

RADIO RETAILING

25 CENTS PER COPY

McGraw-Hill Publishing Company, Inc.

OCTOBER
• 1938 •

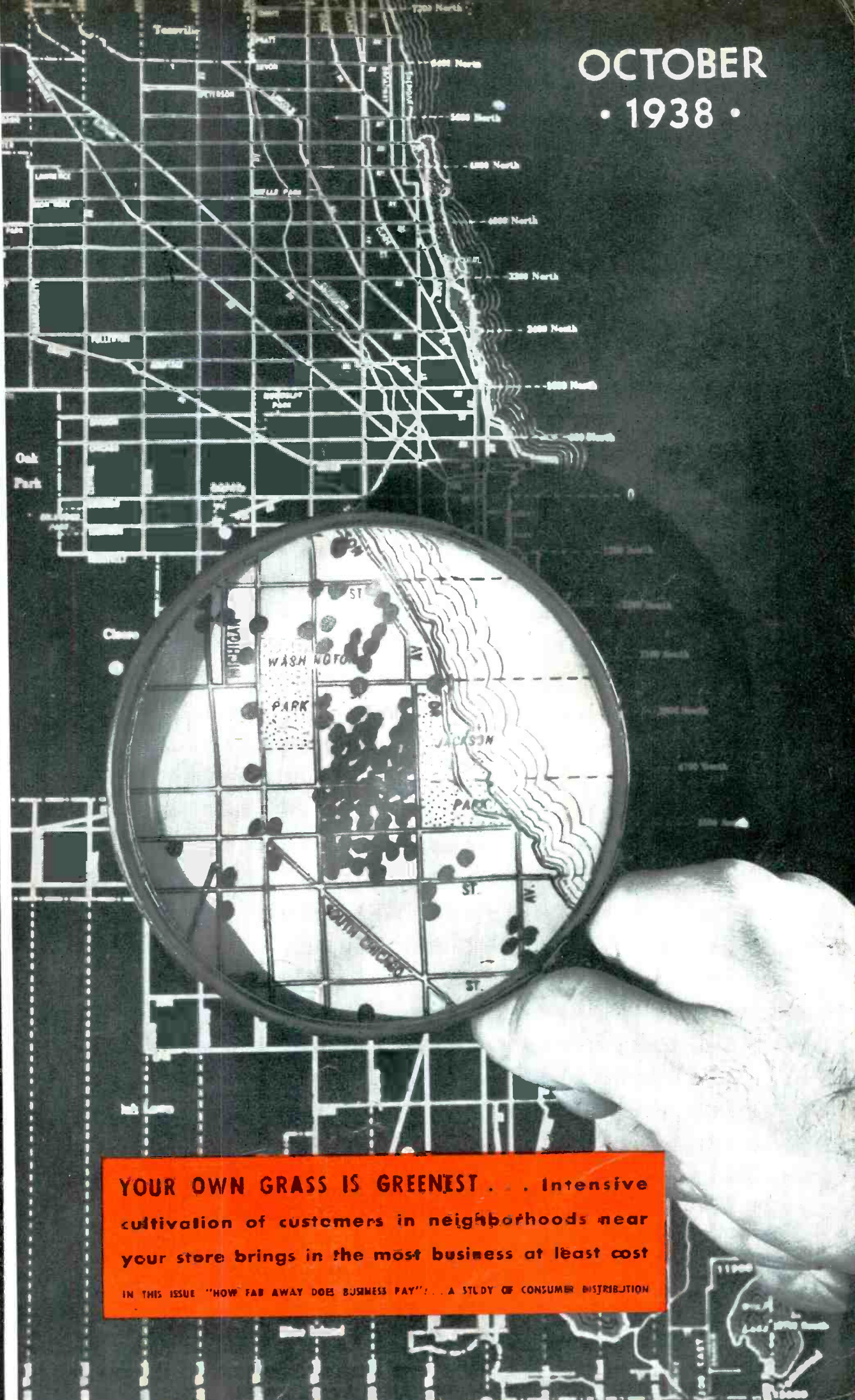

YOUR OWN GRASS IS GREENEST . . . Intensive cultivation of customers in neighborhoods near your store brings in the most business at least cost

IN THIS ISSUE "HOW FAR AWAY DOES BUSINESS PAY" . . . A STUDY OF CONSUMER DISTRIBUTION

For the FIRST TIME in the Industry

Completely Standardized

P.R. MALLORY & CO. Inc.
MALLORY Fabricated
Plate*

***FP CONDENSERS**

**New, Compact Trouble-Free
 Units Having Exceptional
 Range of Application**



Specified for original equipment by leading radio manufacturers, new Mallory FP Condensers are now available to radio service engineers, amateurs and experimenters. They are ideal for construction purposes and for all service applications where the special characteristics of these new condensers are of vital importance.

Two years of research and intensive development by Mallory engineers have gone into the final perfection of these revolutionary Fabricated Plate Condensers. A minimum ratio of 10 to 1 accomplished without acid etching provides extremely small sizes without squeezing, or sacrificing any of their excellent electrical characteristics.

Again Mallory provides revolutionary features.

1. Small size without a sacrifice of safety or efficiency.
2. Low R. F. Impedance. Quieter operation of vibrator powered sets.
3. Long life due to chemical purity and freedom from corrosion.
4. Surge proof construction obtained through new separator materials.
5. Better filtering efficiency.
6. Permanent identification of condenser ratings.
7. Improved performance for battery sets with minimized battery drain.
8. Improved sealing against unusual humidity or heat.



TYPE BB

P.R. MALLORY & CO. Inc.
MALLORY

Fabricated Plate Tubular Condensers

New Mallory Type BB Condensers, with exclusive Fabricated Plate construction offer in a "tubular" all the typical advantages of the Mallory FP Condenser. Made with a one piece drawn aluminum can and covered with heavy, deeply embossed cardboard tube for rating identification. Equipped with heavy leads . . . no thin foil tabs.

**YOUR DISTRIBUTOR HAS COMPLETE INFORMATION ON
 THESE TWO AMAZING NEW CONDENSERS. SEE HIM TODAY.**

Use

P.R. MALLORY & CO. Inc.
MALLORY
 REPLACEMENT
 CONDENSERS . . . VIBRATORS

P. R. MALLORY & CO., Inc.
 INDIANAPOLIS INDIANA
 CABLE ADDRESS—PELMALLO

Use

YAXLEY
 REPLACEMENT
 VOLUME CONTROLS

RADIO RETAILING

A McGRAW-HILL

PUBLICATION

OCTOBER 1938



O. FRED. ROST Editor
 W. MacDONALD. Managing Editor
 C. A. NUEBLING. Technical Editor
 J. H. AVELING. Assistant Editor
 HARRY PHILLIPS. Art Director

Tom Blackburn Chicago George Tenney San Francisco

H. S. Knowlton Boston

H. W. MATEER Manager

LEE ROBINSON Sales Manager

McGRAW-HILL PUBLISHING COMPANY, INC.

JAMES H. McGRAW
 Founder and Honorary Chairman

Publication Office
 99-129 North Broadway, Albany, N. Y.
 Editorial and Executive Offices
 330 West 42nd Street, New York, N. Y.

Cable Address: MCGRAWHILL, New York
 Member A.B.P. Member A.B.C.

James H. McGraw, Jr. President
 Howard Ehrlich. Executive Vice-President
 Mason Britton. Vice Chairman
 B. R. Putnam. Treasurer
 D. C. McGraw. Secretary
 J. E. Blackburn, Jr. Circulation Manager

RADIO RETAILING, October, 1938, Vol. 23, No. 10. Published monthly, price 25c copy. Subscription rates—United States and possessions, Canada, Mexico and Central American countries, \$1. All other countries \$2 a year or eight shillings. Printed in U. S. A. Entered as Second Class Matter, September 8, 1936, at Post Office, Albany, N. Y., under the Act of March 3, 1879. Cable address "McGrawhill, New York." Member of A.B.P. Member of A.B.C. Copyright 1938 by McGraw-Hill Publishing Co., Inc., 330 West 42d Street, New York, N. Y.

Branch Offices: 520 North Michigan Ave., Chicago; 383 Mission St., San Francisco; Aldwych House, Aldwych, London, W.C. 2; Washington; Philadelphia; Cleveland; Detroit; St. Louis; Boston; Atlanta, Ga.

Public Relations and the Radio Industry

Page 25 to page 40

HIGHSPOTS OF THE RADIO MONTH.	By O. Fred. Rost	9
BUSINESS BAROMETER, SEPTEMBER FIGURES.		11
IT'S THEIRS, ALMOST.		15
SALES PHOTOSHORTS		16
HOW FAR AWAY DOES BUSINESS PAY?	By Charles Phillips	18
RADIO RETAILING TUBE CONTEST WINNERS.		20
YOUR ANSWER MAY BE AIR-CONDITIONING.	By Fred Merish	22
RECORDS FOR SOUND WORK.	By Robert S. Nash	23
NAMES IN THE NEWS.		42
PREVIEW OF NEW PRODUCTS.		56
SERVICING HOME-CHARGERS.	By H. D. Hooton	67
CIRCUITS		70
TRICKS OF THE TRADE.		76
READERS MAKE THEMSELVES HEARD.		84

SALES STATIC . . . "He wants to know how much it's worth on a trade-in"



6 REASONS WHY STROMBERG-CARLSON SALES ARE SOARING



1

THE PATENTED LABYRINTH. A long, winding passageway of sound absorbent material which absorbs the cavity "boom" from back of speaker. It gives deeper bass notes with new fidelity and increases the volume capacity and accuracy of the speaker.



2

EAR-LEVEL PROJECTION. Until the Labyrinth eliminated cavity "boom" the loudspeaker had to be placed near the floor. Now it can be placed so as to project sound at "Ear-Level" where the rugs and upholstered furniture will not absorb needed treble tones.



3

CARPINCHOE LEATHER SPEAKER. The Stromberg-Carlson speaker come fairly "floats in air"—free to follow every tiny impulse in the rendition of music. That's because the speaker edge suspension is of soft, flexible, and moisture-proof Carpinchoe Leather.



4

AUTHENTIC DESIGNS. Reproductions of the beautiful cabinets of the master furniture craftsmen—Duncan Phyfe, Chippendale, Heppelwhite and others give an appeal that is new to radio. Will fit in any room.



5

FOUR WOODS TO CHOOSE FROM. Your choice of a variety of woods, too, in the new Stromberg-Carlsons. There is mahogany or maple, rosewood or walnut—whatever style and wood YOUR room demands.



6

PHONOGRAPH RECORDS CAN BE PLAYED. All Stromberg-Carlson radios are equipped with built-in phonograph jacks, or can be adapted quickly and easily by the dealer for connecting separate record player.

Think how these *exclusive* features will interest people who are considering a new radio. Add to them the unusual operating conveniences; the high quality which Stromberg-Carlson always

have possessed; the sharply competitive prices—and you will realize why the sales of the 1939 Stromberg-Carlsons are soaring and delighting authorized dealers from Coast-to-Coast.

Prices from \$39.95 to \$795 f. o. b. Rochester. Send coupon.

There Is Nothing Finer than a

Stromberg-Carlson

Stromberg-Carlson Telephone Mfg. Company
208 Carlson Road, Rochester, N. Y.
Send full information on *Radio's Finest Line.*

Name _____
Street _____
City _____ State _____

RAYTHEON RADIO TUBES
FIGHT FIRE
WITH THE
U. S. FORESTRY SERVICE!



Nothing but the best will do in protecting Uncle Sam's billion dollar forests. That is why RAYTHEON radio tubes have been drafted to stand watch in communications receivers vital to the U. S. Forestry Service!

Successful Dealers and Servicemen—those who are in business to stay—are finding that Raytheon tubes are their insurance of the best—for permanent tube profits. And a wise investment. Yet they *cost no more* than the second-best tube!

Ask your RAYTHEON jobber for your copy of RAYTHEON'S *FREE* Sales Helps, illustrated below.

RAYTHEON

NEWTON, MASS. • NEW YORK
 CHICAGO • SAN FRANCISCO • ATLANTA

"WORLD'S

LARGEST EXCLUSIVE RADIO TUBE MANUFACTURERS"

TAKE YOUR COMPETITION WITH LOWEST PRICED QUALITY CONSOLES IN THE FIELD

TWO DISTINCTIVE CONSOLES OF *Grace* AND *Charm*

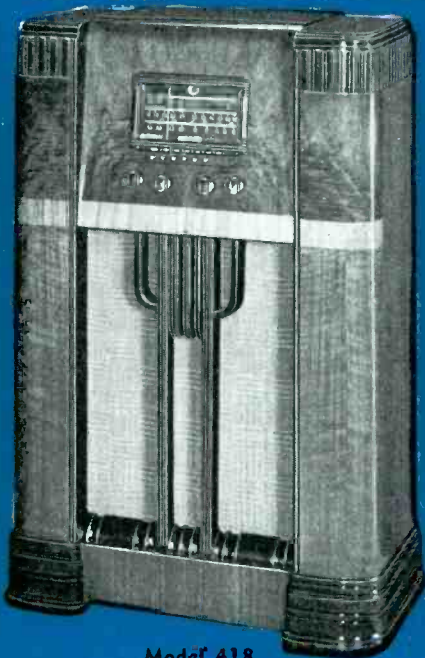

Model 418

(A super-performer) 12-tube A.C. all-wave superheterodyne (22,000-540 K.C.) Perm-a-matic push button tuning. True Bass Boost Tone Control. New slide rule with angle dial. Electronic tuning eye. Inclined control panel. Push pull beam power output capable of developing 9 watts. 12" dynamic speaker. Phonograph connection. Cabinet by Castlewood of stump walnut trimmed with oriental walnut and primavera wood. Inclined tuning panel. Underwriters' approved. Receives American and ALL Foreign short wave broadcasts, police, amateur, aviation, ships.

\$ 89⁹⁵ PRICES HIGHER IN THE SOUTH AND WEST OR ROCKIES **\$ 59⁹⁵**

TWELVE TUBE

SEVEN TUBE

DISTRIBUTING PROPOSITION IS OPEN IN SOME TERRITORIES. CALL OR WIRE COLLECT.

HOWARD RADIO CO.
1731 West Belmont Avenue, Chicago, Illinois
America's Oldest Radio Manufacturer

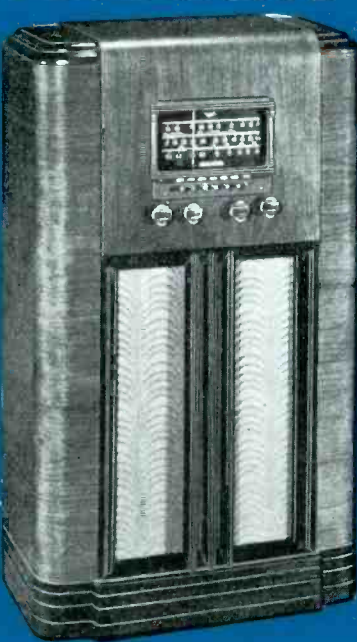

Model 378-D

(A popular favorite) 7-tube all-wave A.C. superheterodyne tuning to 22,000 K.C. Has exclusive Howard Perm-a-matic push-button tuning eliminating electrical drift. New slide rule all angle dial. Electronic tuning eye. Phonograph connection. Flywheel manual tuning. Beam power output with 12" dynamic speaker. Cabinet by Castlewood of matched walnut. Underwriters' approved. Receives American and ALL Foreign short wave broadcasts, police, amateur, aviation, ships.

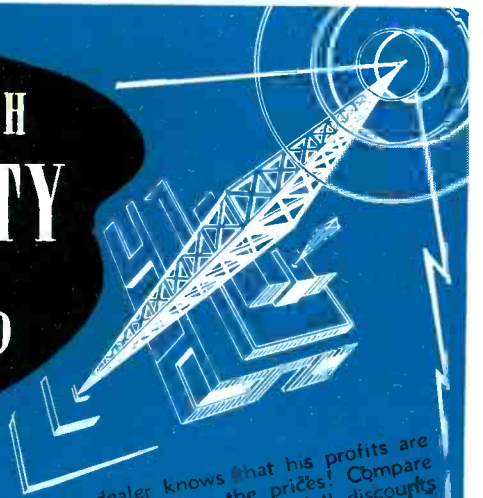

And every dealer knows that his profits are made in consoles. Compare the prices! Compare the quality! With Howard you get full discounts—handle any models you wish—buy as you please, and... most important of all you sell QUALITY MERCHANDISE BACKED BY THE OLDEST RADIO MANUFACTURER IN AMERICA.

The WELL BALANCED HOWARD LINE is MAKING MONEY for DISTRIBUTORS and DEALERS . . .

HOUSEHOLD SETS: Howard covers the popular price range with twelve outstanding A.C. and A.C.-D.C. receivers . . . Three Farm Radios and one Auto Radio. Every Howard radio is built with standard high quality parts and has the distinctive Howard copper plated chassis.

A FEW OF HOWARD'S IMPORTANT CONTRIBUTIONS TO 1939 RADIO

Bass Boost Tone Control—Ordinary tone controls simply cut off part of the frequencies. Bass Boost Tone Control amplifies the bass notes at any volume level, leaving the high notes in and thus insuring beautiful, well-rounded tone beyond the range of ordinary radios.

Perm-a-matic Tuning—Push-button tuning that does not shift—any button may be set for any desired station anywhere on the dial.

Cabinets—Howard consoles were created by an internationally famous furniture designer and are produced in the Castlewood factory, makers of fine furniture.

COMMUNICATION RECEIVERS—Howard's three models of receivers for amateurs and professionals is literally taking the market by storm.

For information write—

Howard Radio Co.
1731-35 W. Belmont Ave.
Chicago, Ill.

Please send folder and prices
Howard Home Receivers
Howard Communication Receivers
CABLE ADDRESS: "Howardco"

Special 6-Tube P.A. Tuner

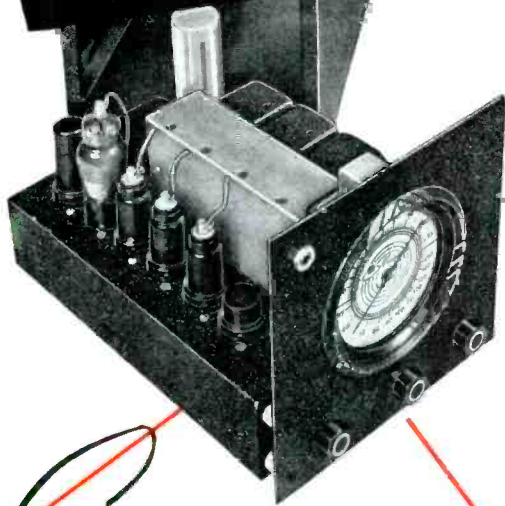

Wire It Yourself!

Here is the special-purpose job you have been looking for. It is a T.R.F. circuit designed just for P.A. work. Provided with a dual audio-output channel, so that one channel may be used for monitoring purposes without giving, in the P.A. channel, any indications of the switching done in the monitoring circuit. The absence of oscillators makes this a tuner absolutely non-interfering regardless of the number that may be grouped together in a multiple-channel P.A. system. **\$23.25**

Special Features

- 530 TO 1600 KC COVERAGE
- FOUR TUNED CIRCUITS USING FERROCART (IRON CORE) SHIELDED R.F. TRANSFORMERS
- 4-GANG PRECISION TUNING CONDENSER
- HIGH-Q COILS—ENORMOUS GAIN AND SELECTIVITY
- FULL AUTOMATIC VOLUME CONTROL
- AUDIO GAIN AND TONE CONTROLS
- WORKS WITH ANY AMPLIFIER INPUT
- SELF-CONTAINED POWER SUPPLY

This P.A. Tuner is supplied in complete kit form including all coils, 4-gang variable condenser, power transformer, fixed condensers, resistors, sockets, knobs, dial and escutcheon, punched and drilled heavy steel chassis, miscellaneous small parts, hardware, pictorial and schematic diagrams and clearly written detailed instructions for assembling, wiring and operating. (NOT including Panel, Cabinet or Tubes.) And it is GUARANTEED to work satisfactorily or the Meissner Manufacturing Company will fix it for you—even supplying a shipping carton for returning it to the factory!

Tuner is designed so that two of them can be mounted side by side in one relay-rack panel, (8 $\frac{3}{8}$ " x 8 $\frac{3}{8}$ " x 12 $\frac{1}{2}$ ".) Also making it small enough for portable use. Contains its own power supply. Operates from 110-volt line. Black crystal front panel 75c. Black crystal cabinet \$2.85. ASK YOUR PARTS JOBBER.

SERVICE PARTS

VIBRATORS

ADAPTER KITS

TUNING UNITS

COMPLETE RECEIVER KITS

MT. CARMEL,
ILLINOIS



Meissner

"A FAMOUS NAME FOR TWO DECADES"

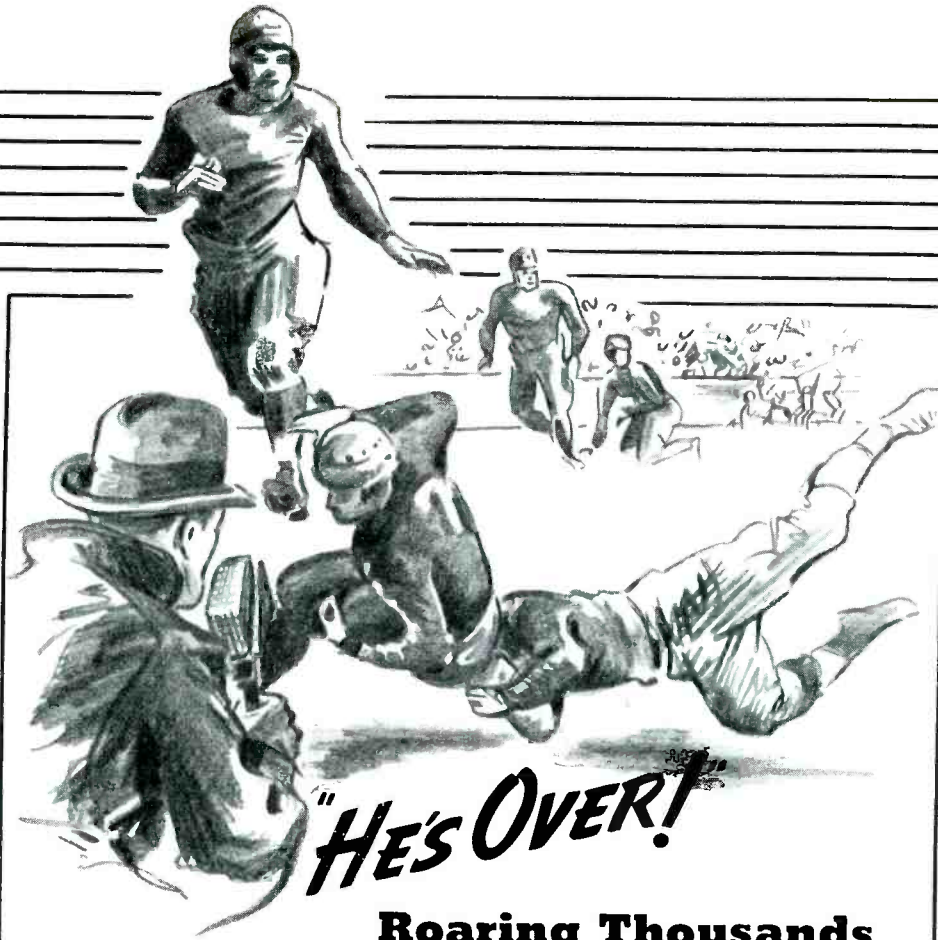

"HE'S OVER!"
Roaring Thousands
Thrill to These Words from Giant
Utah **Speakers!**

On the sidelines, close to the playing field, the announcer watches every play—in the stands or high up on the scoreboard, Giant Utah Speakers bring his observations to the frenzied crowd—and again Utah Speakers are demonstrating their ability to deliver perfect performance when conditions are unusual and difficult.

You can make a "touchdown" on every service job when you stick to Utah Products—they're engineered right, built right and their performance is right. For genuine customer satisfaction, the kind that builds business, ask your jobber for "UTAH" Products.

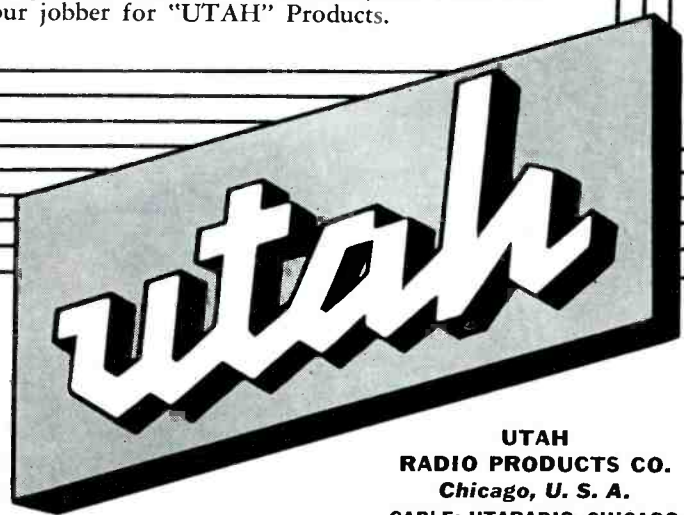

UTAH
RADIO PRODUCTS CO.
 Chicago, U. S. A.
 CABLE: UTARADIO, CHICAGO

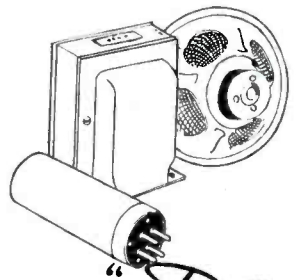

"Dependable Since 1922"

Every dealer's "sales team" needs these profit scorin'

All American

ARVIN RADIO S



AC-DC Model 58A \$19⁹⁵ LIST
Beautiful Ivory Plastic Cabinet.
Dial Tuning.

A full-sized superhet using 5 tubes plus ballast tube. Provides splendid station coverage and fine quality reception. Two companion models, same style as above: AC-DC Model 58, 5 tubes plus ballast. Ebony black plastic. Dial tuning. \$16.95. AC Model 68, 5 tubes with six push button automatic tuning and Station Variator. Walnut plastic. \$24.95.

AC MODEL 88 \$39⁹⁵ LIST
Fully Enclosed Radio-Phono-graph. 6 tubes.

Reproduces radio broadcasts and phonograph recordings beautifully. Fine quality superheterodyne using 5 tubes plus ballast tube. Fully enclosed walnut wood cabinet. Plays 10" and 12" records.

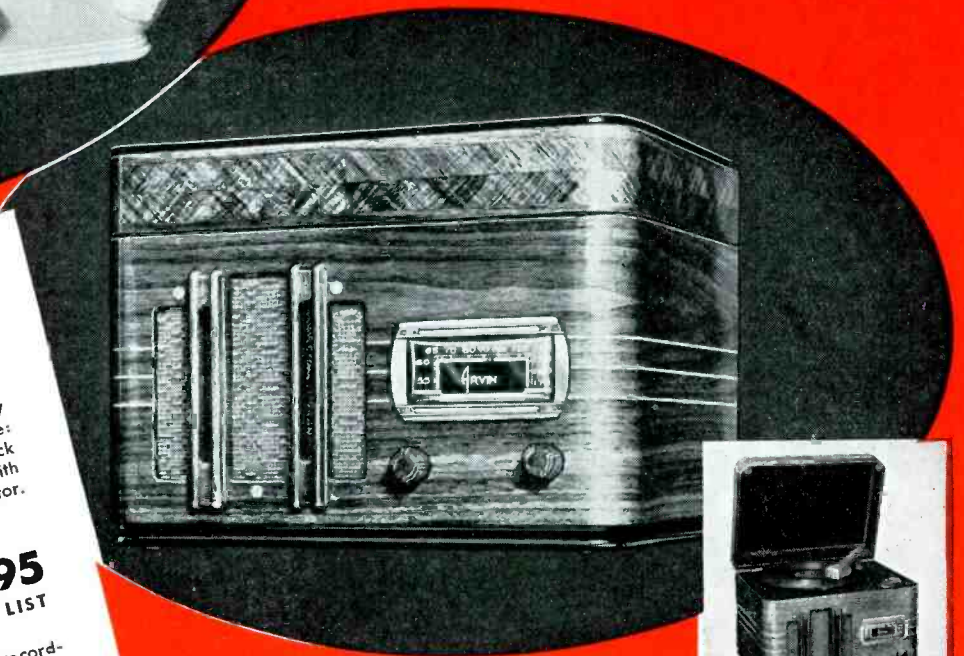

Right: Lid raised to show phonograph of Model 88.

Modern, Snappy Gold Foil Display FREE with the Arvin No. 30 Deal

Set up your sales drive on the new Arvins with this "eye appealing" window-counter display. It is free with an order for any three Arvin table radios. Ask your jobber.



● With these new Arvin table radios your "sales team" will have the profit-punch to roll up volume and extra earnings. They're "All-Americans" in every way. Full-sized radios that bring in American stations, with fine selectivity and good tone quality.

These new Arvins are styled so beautifully—built so well—and priced so reasonably—they appeal to "All-Americans" from high school freshman to college senior, from housewife to business man.

Plastic and walnut wood cabinets have the value-plus sales appeal of push button tuning, dial tuning or a combination of both. See your Arvin catalog for full details on these and all the fine quality radios in the complete Arvin line.

NOBLITT-SPARKS INDUSTRIES, Inc. • COLUMBUS, INDIANA

Prices slightly higher in extreme south and west.

THE ARVIN LINE IS COMPLETE, INCLUDING CONSOLE, CHAIRSIDE, TABLE AND BATTERY RADIOS



HARRY BOYD BROWN
National Merchandising
Manager of Philco

First Returns—As We Go To Press— On Public Response To Philco Mystery Control

AT this moment—in local newspapers throughout America—Philco dealers are making their first announcements of Philco Mystery Control to the public. By the time this publication reaches you, the actual results of this advertising will be a matter of history.

But even now—as I write this editorial—early exhibits and demonstrations of Mystery Control already have created an amazing wave of public interest, excitement and response. Now the retail buying public will get the thrill that you folks in the trade got 4 months ago.

As this paper goes to press—it is too early for me to give you any figures on the newspaper advertising results. However, here are some exciting advance experiences in public reaction to Mystery Control—the result of demonstrations at Fairs and Expositions early in September.

“The management of the Washington County Fair at Hoosick Falls, New York, requested Mystery Control as one of the acts of the big vaudeville show at the Fair Grounds,” writes William J. Rouditis of the Hoosick Radio Service, *“and Mystery Control was the sensation of the show. After the demonstration, it seemed to me that the entire crowd in the grandstand swarmed over to our Philco booth.”*

A Sanford, Maine dealer sold 12 Mystery Control models during a 3-day demonstration at a County Fair. More than 100,000 people witnessed a demonstration of Philco Mystery Control at the New York State Fair in Syracuse. Every Philco dealer was entirely sold out of Mystery Control models within 24 hours and back orders were piling up.

Philco Mystery Control stopped the show at the Elgin Merchants and Manufacturers Exposition in Elgin, Illinois, last week. It was exhibited and demonstrated by the Kimball Furniture and Rug Corporation of Elgin. And here is what Mr. D. C. Williams of the Kimball Store writes us:

“Without asking one single person to buy, 18 people left their names and addresses and asked us to deliver a Philco Mystery Control model to their home. In addition, over 100 people left their names and addresses with the request that we come to their home and appraise their old radios.”

“In my 17 years of selling radios, it is the first time I have ever had the thrill of such an experience—18 bona fide customers plus 100 golden prospects with hardly a word of selling pressure on the part of our salesmen.”

Yes, in Philco Mystery Control the retail radio dealer has a traffic-getter without parallel in the radio industry—an advertising attraction so new and so revolutionary it will pack your store with truly interested prospects.

Harry Boyd Brown

PHILCO

The RADIO MONTH

OCTOBER

1938

A Radio Peace The world recently passed through the most anxious weeks that it has experienced since that day in 1914 when a fanatic shot and killed an archduke.

Then an unfortunate incident was followed by interminable hours and weeks of dark foreboding while secret diplomacy played poker, using the fate of nations as chips. The men and women of a continent and the world were fed on such crumbs of news as enterprising reporters could conjure or pry loose from diplomacy's underlings. Published statements of diplomatic bigwigs were mostly eyewash. The one whole truth that finally was allowed to reach the light of day spelled WAR. Followed the greatest disaster that modern civilization ever has suffered.

Last month the situation seemed no less serious. There had been unfortunate incidents. There were threats. Mobilization of armed forces proceeded at a pace the world never before had seen. Again the fate of nations and continents was at stake.

But, barely had a conference ended when the microphone was called into play and the important negotiators stated their case to the radio audiences of their own nation and a listening world. Reactions bounced back with lightning speed, were carefully noted and studied. Heads of other governments had a chance to register sentiment and opinions of their populace. When the last conference had ended, the ether waves carried the welcome word PEACE.

Only future historians will be able to appraise accurately the full extent of radio's contributions to the cause of peace. Certain it is that the impact of radio-mobilized reactions had a profound influence upon

the course of the conferences and their final results.

The radio industry has cause to be proud of this accomplishment, but in particular we in the United States can be proud of the outstanding service that the broadcasting networks rendered the American Public in keeping it constantly and fully informed on current developments.

The splendid reporting services direct from the sources of news, the frequency and speed with which reports reached here, and the clear and unbiased interpretations that were supplied by our American broadcasting stations during those critical weeks loom large as a monument to the freedom and the efficiency of the system upon which the American radio industry is built.

Public Relations It's a mighty big and serious public relations problem that the radio industry has on its hands, but only a few of the thousands who depend on it for a living, and fewer of the millions of daily radio listeners are conscious of its existence.

The radio industry as a whole represents what is perhaps the most shining example of what can happen under the American concept of free enterprise. Radio manufacturers have millions of dollars invested in plants and machinery, and invest added millions annually in manufactured products because they take broadcasting for granted. Dealers invest in stocks of sets because they take broadcasting for granted. The public buys sets because it takes a 24-hours per day flow of the world's finest broadcast programs for granted.

All too little has been and is being done to force the realization that those broadcast programs are the

symbol of a system under which they come at no cost, without listeners or license fees, free as the air that carries them.

The industry should sponsor an organized effort to make the public more completely conscious of the privilege that it now enjoys and deserves to protect. In this issue, *Radio Retailing* presents a special insert on the subject of public relations in which pertinent facts are supplied to those who might wish to enlist in the cause of building better understanding and wider appreciation of what radio and broadcasting contributes to modern living.

Antennas and Tubes It is to be regretted that attempts to focus dealers and servicemen's attention on the value of antenna check-ups as sales and profit builders have not met with greater success.

Antennas, like tubes, are neglected by the majority of set-owners, and few are conscious of the deteriorating effect they may have on reception until something goes radically wrong—then everybody wants service-at-once.

The idea of buying systematic and periodical check-ups of antennas and tubes can be sold to the public just as readily as the automobile industry has sold the idea of regular check-ups on tire pressure, periodical oil changes and lubrication.

For the dealer, a check-up campaign forms the ideal vehicle for gaining a chance to sell a new set to an old customer. To the serviceman the check-up plan seems almost indispensable. It surely is a natural bridge to more business. Use it.



EDITOR

ARE YOU *Buying* RADIO TUBES

...OR *Selling* THEM?

You need planned sales help to sell tubes—and here's what RCA does to help you!

1. Current "Money Back" promotion
 2. Consumer advertising
 3. Window display service*
 4. Sales helps for use in your store
- Full details from your distributor.**

Over 325 million RCA radio tubes have been purchased by radio users ... in tubes, as in radio sets, it pays to go RCA ALL THE WAY.

RCA presents the Magic Key every Sunday, 2 to 3 P. M., E. S. T., on the NBC Blue Network.



***New Fall Display Ready**

The attractive football display shown here is now available for use in your window. Timely, colorful, and informative, it will stop people at your store. Ask your RCA distributor how you can get this display for your own use.

RADIO TUBES

RADIOTRON



**GUARANTEED
BY
RCA
(WRITTEN GUARANTEE INSIDE)**

RADIO TUBE

**SEALED and TESTED
at the factory for
YOUR PROTECTION**



Radiotrons

RCA Manufacturing Co., Inc., Camden, N. J.
A SERVICE OF THE RADIO CORPORATION OF AMERICA

BUSINESS BAROMETER

SEPTEMBER retail sales of radio sets pushed our barometer up another point, so that now it stands at 93 and only 7% below unit sales for the same month of 1937.

In continuing the rise it started in July, the sales curve for radio sets is following closely the course that was previously predicted, namely, a gradual narrowing of the gap between last year's and this year's unit sales until it would disappear.

Sales Are Up

When the movement of the barometer is compared with last month, there is only one point of improvement of performance but this in no way reflects the real upswing of sales that can be noted when sales reports of a majority of individual dealers from various parts of the country are studied.

There are no longer the big declines of volume which for so long kept hundreds of dealers at from 25% to 50% below last year, nor are there the contradictory increases in sales which very active retailers reported and which made our statisticians jittery and suspicious.

Taken for the country as a whole, the reports of September sales represent the most uniform trend of radio set sales that this barometer has been able to record. With very few exceptions the sales reports show an upward trend over previous months, and spots where that is not the case can prove an alibi, in

that a known localized economic or industrial situation is causing it.

Those Three-I States

The three old-line corn-belt states—Illinois, Indiana and Iowa—finally have gotten together on set sales performance and dealers' reports have ceased to show drastic differences. True, there are still many dealers whose unit sales are down uncomfortably, but the bulk of them in those states shows near-1937 totals.

In some of the states bordering on the corn belt, crop and price conditions seem to have caused a pause in buying, because sales of dealers who were riding along at good pace have slowed, although a few say that buying picked up nicely during the last days of September.

Storm Blown New England

It's not possible for us to say definitely that the hurricane which invaded New England actually did help sales of radio sets, but for some reason or other dealers from Connecticut, Massachusetts, New Hampshire and Vermont surely did better in September than at any time since last December, not a few pushing their unit sales above the 1937 total for the same month.

The same thing holds true with the territory that is generally considered hurricane's favorite playground. Reporting Florida and Georgia dealers had September sales that in quite a few cases equalled

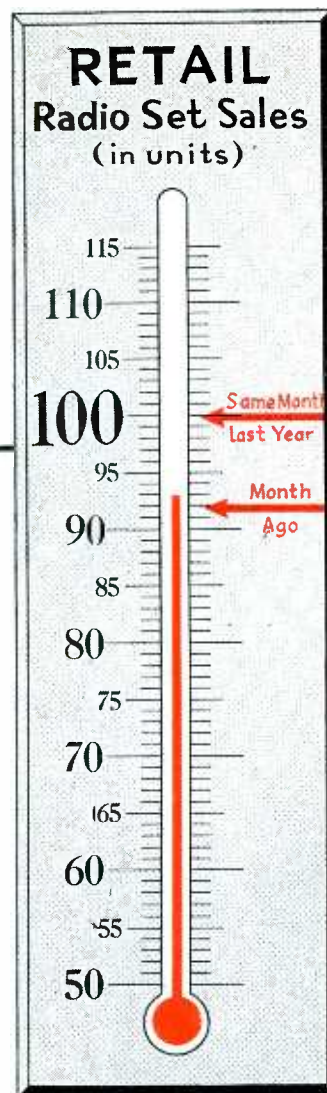

SEPTEMBER

1937. Some Louisiana merchants exceeded their September, 1937 unit sales and Alabamans did equally well.

Pacific Paradox

Somehow the sales reports from the Pacific Coast seem to bear out the often-voiced contention that the southern portion of our Pacific Coast is "different country" from its northern stretch.

The sales report from the coast states vary all the way from showing well above 1937 levels to a sad 20% below and it's hard to figure out reasons, unless it be differences in dealers' ability to sell.

You're Invited

... TO JOIN
SALES

FEATURING
A

\$40 TRADE **40TH ANNIVERSARY**
IN ON THIS **RCA VICTROLA!**

\$40.00 TRADE-IN

We told our factory, our designers, our engineers: "We want the best value that has ever been created—something special—to celebrate the 40th Anniversary of RCA Victor!" And that's why you can offer this amazing new instrument to your prospects with a \$40.00 trade-in on their old radio or phonograph, regardless of make or condition!

\$5,000.00 OLDEST VICTROLA CONTEST

This is a contest in which both you and your customers can win prizes. There will be 20 first prizes of \$250 apiece. These awards will be given to the public in exchange for the oldest Victrola made in each of the 20 years from 1906 through 1925 inclusive. Contestants will be required to secure entry blanks in your store. If one of the winners gets his entry blank from you, you win \$250 in merchandise.

3-WAY COMBINATION SALE BETTER THAN EVER!

With this popular, profitable RCA Victor Combination Offer, which enables you to sell Model 97KG, Victrola Attachment and Victor Record Society membership at a special bargain price, you may now offer the new RCA Victor 40th Anniversary Album of Victor Records, worth \$10.50. It contains recordings by 11 of Victor's outstanding artists. Or your customers may have their choice of \$9 worth of Victor or Bluebird Records.

GET FULL DETAILS ON
40th ANNIVERSARY
SALES CELEBRATION
FROM YOUR RCA
VICTOR DISTRIBUTOR

RCA presents the Magic Key every Sunday,
2 to 3 P. M., E. S. T., on NBC Blue Network
For finer radio performance—RCA Victor Radio Tubes



RCA Victrola

RCA MANUFACTURING CO., INC., CAMDEN, N. J. • A Service of the Radio Corporation of America

RCA Victor's 40TH ANNIVERSARY CELEBRATION

AUTOMATIC RECORD CHANGER

A marvel of gentle yet positive action. Although used on the most expensive Victrolas, this same mechanism is a feature of this 40th Anniversary model.

CRYSTAL PICKUP, TOP-LOADING NEEDLE SOCKET

Crystal Pickup offers extended musical range. Top-loading Needle Socket provides jiffy changing of needles—without pricked fingers!

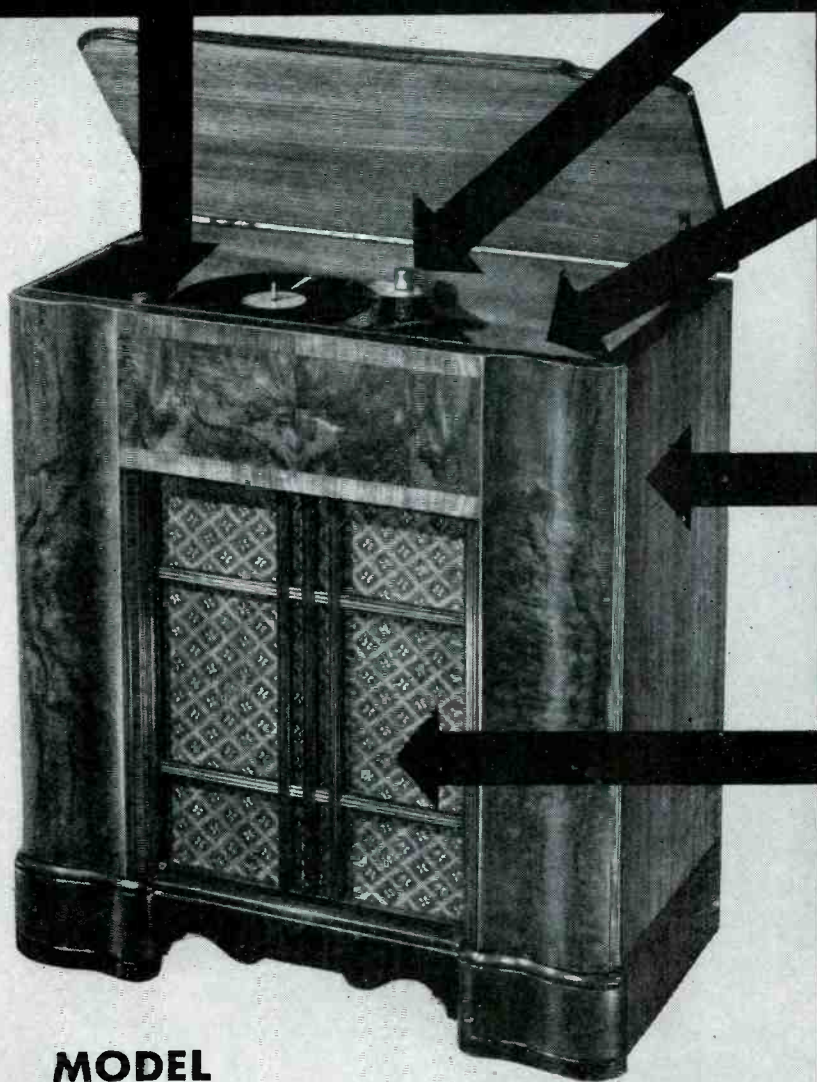

IMPROVED ELECTRIC TUNING

RCA Victor introduced to the world Electric Tuning... "Push a Button—There's Your Station!" Again RCA Victor leads with a finer, faster version of this famous feature.

CABINET OF EXQUISITE DESIGN

Available in either Walnut or Mahogany. For forty years, the products of RCA Victor's cabinet factory have been known as the finest in the industry— heavier, finer, more expertly fashioned.

12" DYNAMIC SPEAKER

Especially designed to faithfully reproduce radio and recorded music of this 40th Anniversary instrument. Delicately responsive to every shading in the music and each inflection of the human voice.

"RCA ALL THE WAY"

An instrument made by the makers of Victor Records, radio and broadcasting equipment, and producers of fine radio programs (NBC).

MODEL
U-125

A remarkable instrument of outstanding quality—offering unheard-of value to prospects and untold profit opportunities to RCA Victor dealers!

Here's a **CHRISTMAS THEME**
you **CAN** merchandise!



*For the Practical Person
with a Sentimental Side!*

CAPITALIZE on this year's trend toward the practical, on the universal desire of all gift-givers to be sentimental. Show your customers that they can be both. Tie in with General Electric's dynamic theme "For the Practical Person With a Sentimental Side". Tell your customers that this is the year to give "the new ease of living". Help them select practical, thoughtful gifts that will be used and appreciated not only on Christmas Day but for years to come.

tastes to worry men shoppers. A mere "Charge it" or a "\$5.00 deposit" delivers and installs the gift of gifts. Promote these easy-to-sell gifts. Promote these profitable-to-sell gifts. Let them roll up a successful Christmas season for you. There's appliance business to be had. Put these 33,450,215 advertisements to work for you. Make G-E's campaign "For the Practical Person With a Sentimental Side" your own. Let it take the sag out of your sales curve.

**GENERAL ELECTRIC GIFTS
ARE EASY TO SELL**

No sizes, no colors, no personal

GENERAL ELECTRIC MEANS BUSINESS

**33,450,215 ADVERTISEMENTS
IN 33 DAYS**

Twelve smashing advertisements in ten leading publications! All double page spreads, except three! All in full color! A powerful campaign to sell electrical appliances as gifts to bring the "new ease of living" to the families of America.

GENERAL  ELECTRIC

DECEMBER ESQUIRE OUT NOV. 11 CIRCULATION 650,000	DECEMBER COUNTRY GENTLEMAN OUT NOV. 15 CIRCULATION 1,645,000	DECEMBER AMERICAN MAGAZINE OUT NOV. 15 CIRCULATION 2,200,000	DECEMBER GOOD HOUSEKEEPING OUT NOV. 30 CIRCULATION 2,311,000	DECEMBER AMERICAN HOME OUT NOV. 30 CIRCULATION 1,152,000	NOVEMBER 26 th SATURDAY EVENING POST OUT NOV. 22 CIRCULATION 3,035,000
DECEMBER 3 rd COLLIER'S OUT NOV. 25 CIRCULATION 2,637,000	DECEMBER 3 rd SATURDAY EVENING POST OUT NOV. 29 CIRCULATION 3,035,000	DECEMBER 10 th COLLIER'S OUT DEC. 2 CIRCULATION 2,637,000	DECEMBER 6 th THIS WEEK OUT DEC. 4 CIRCULATION 5,415,000	DECEMBER 17 th LIBERTY OUT DEC. 7 CIRCULATION 2,167,000	DECEMBER 11 th AMERICAN WEEKLY OUT DEC. 11 CIRCULATION 6,760,000

MAIL TODAY

General Electric
Room 1208, 570 Lexington Avenue
New York City

Yes Sir! I want to wind up 1938 in a blaze of sales and profits. Please send me all details.

Name.....
Firm.....
Street.....
City.....
State.....

RR

SEE THE GENERAL ELECTRIC RADIO AD ON THE BACK COVER

RADIO RETAILING

OCTOBER, 1938



IT'S THEIRS

... *almost*

REPLACEMENT selling virtually dictates side-by-side comparison of old and new sets. And the home is the only place that such demonstrations may be practically staged.

Chief disadvantage of trial outside the store, aside from cost of time and transportation most dealers are resigned to writing off as necessary sales expense, is the scratching, scarring and nicking of new receivers put out on this basis. Many are unsold, come back to the store looking like second-hand goods.

Two important objectives may be attained, thinks Texan George Turney of Houston's Crumpacker Distributing, by wrapping demonstrators in the new, heavy-bodied Cellophane now used to protect hats, other merchandise much

handled before sale. By cutting holes for control knobs, power cable, antenna posts, vents for the speaker, the set can be connected up and tuned yet will resist even such hard knocks as those administered by carelessly wielded electric sweepers. At the same time the packaging dresses up the job much as if it was a box of bon-bons, the set's value rising in the eyes of the prospect in direct proportion to the care taken that its finish and complicated mechanism may be kept free from harm.

The wrapping protects the set, flatters its appearance and is at the same time a reminder that it is only in the home on trial. Selling is aided by the psychological fact that few people can refrain from opening a package. And they have to pay for this one before they can!



MECHANOS, COMBINATIONS, HIT OF HOME SHOW

The "World Famous Mechanos," team of talented humans who have trained themselves to move stiffly, jerkily as wooden dolls, stepped out to music supplied by Ansley Dynaphones, stopped the recent Westchester Home Show held at White Plains, New York. Performances were given several times each day

EGYPTIAN PROPAGANDA

Grun Brothers of Cairo, Egypt (Emerson radio distributor) owns ten sound trucks, frequently loans these to the government to carry medical propaganda to outlying villages. Part of the equipment is DeVry projectors, Homelite power plants

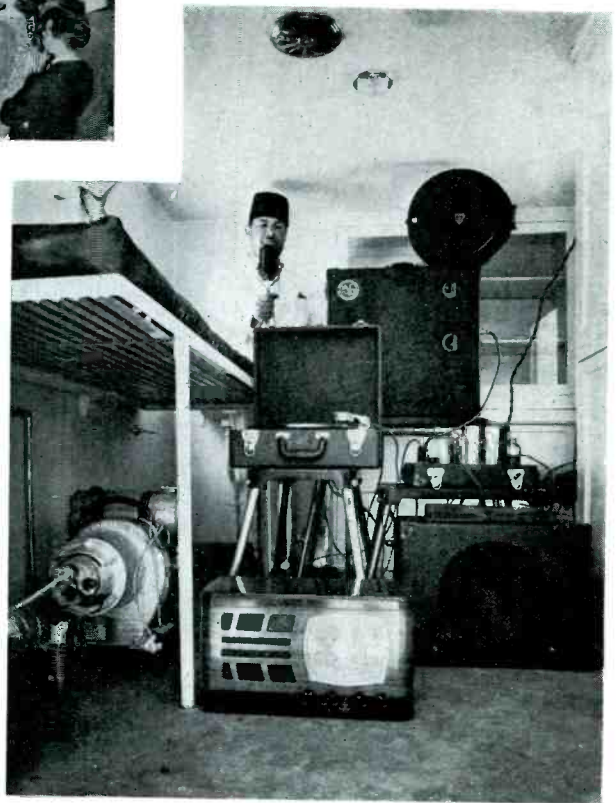

MYSTERY WITH A VENGEANCE

First of a deluge of similar sales ideas to come to our attention relative to Philco's "Mystery Control" was this photo from the Gus Blass Company of Little Rock. The "sandwich girl" paraded before the store, preceded by a salesman walking backward. Result: Names of 500 prospects



MODERN HURDY-GURDY

Distributor W. E. Krueger (center) has been collecting crowds on the main street of Syracuse by parading up and down carrying one of the new Philco portables playing full-blast. Stunt got his picture in the papers

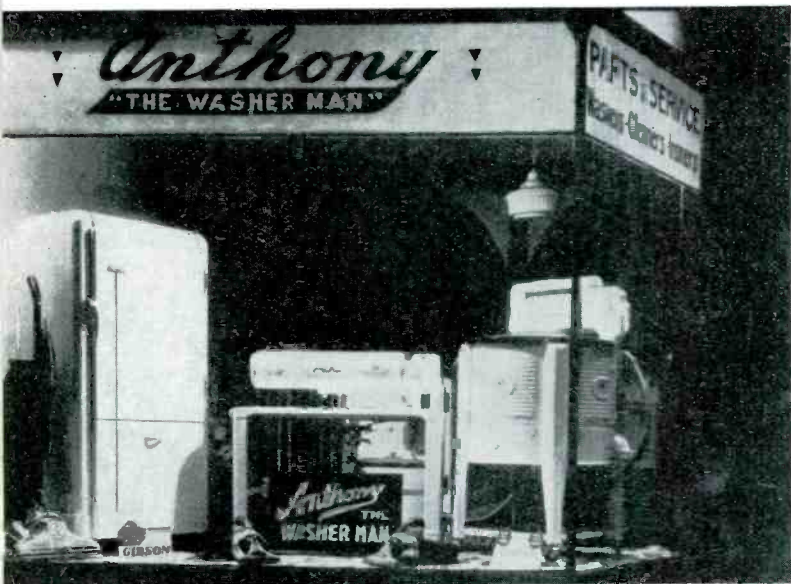

SERVICE, APPLIANCE STEPPING-STONE

Originally a washer serviceman, Anthony of Schenectady (NY) was induced to take on ABC washers, ironers. His reputation as a repairman, he soon found, brought people in with sufficient confidence to buy. Again using service as an approach, he took on Gibson refrigerators, with similar results

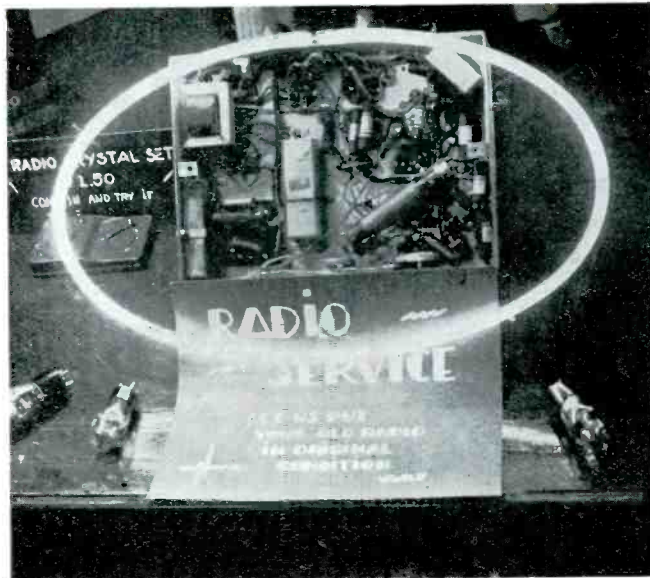

RING AROUND RADIO

Service display par excellence was this neon ring circling an up-ended chassis in the window of the State Appliance Company of Alameda, California. It stressed the presence of many delicate parts, helped business. Neon ring from a discarded sign

YOU BLOW THROUGH HERE

Clever demonstration display designed to prove "Labyrinth" design aids tone are these two long tubes by Stromberg-Carlson. One is lined with acoustic material, the other a plain, hard surfacing. Customers listen at one end while salesmen talk, whistle, clatter noise-makers at the other

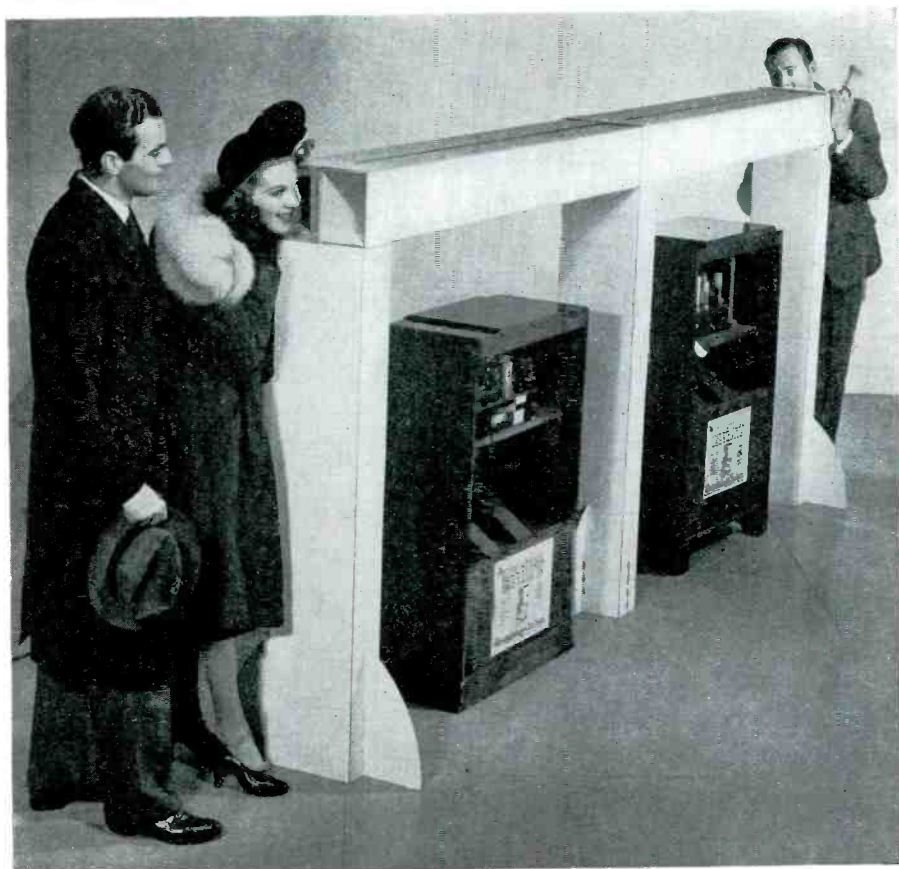

FARMERS FLOCK TO CHEAP POWER

Typical of the many outdoor displays drawing crowds wherever there are country fairs is this set-up by a Parris-Dunn dealer. Reported are a large number of direct-sales right at the booth, attributed largely to almost self-displaying character of merchandise

HOW FAR AWAY

By CHARLES PHILLIPS

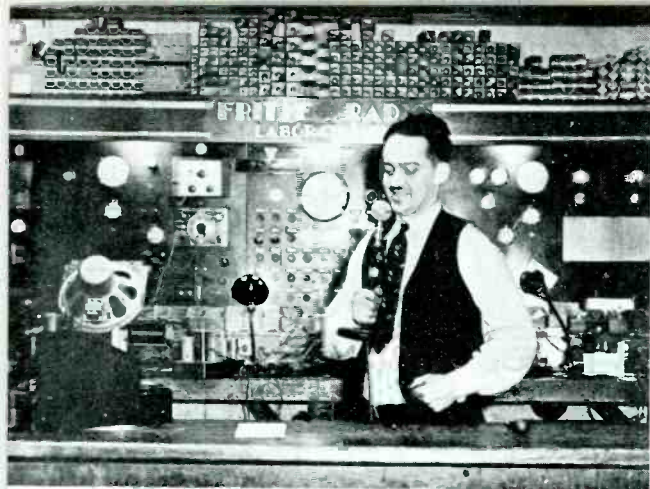

+ FRITZEL

● AMERICAN

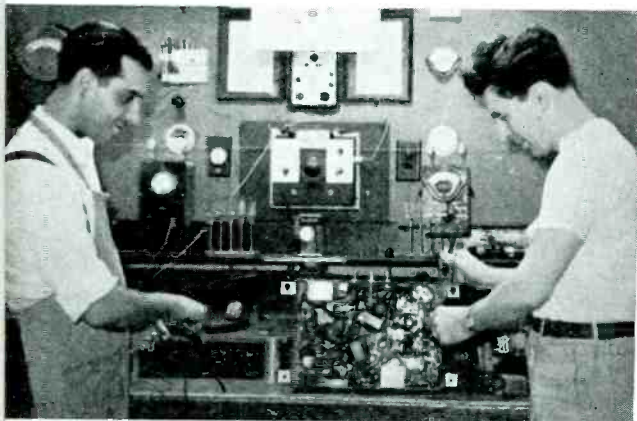

▲ SOUTHTOWN

■ EMERGENCY



HOW far away from the store does business pay? At what distance does the expense of obtaining customers and the overhead associated with the handling of calls at a distance in direct competition with operators in the immediate neighborhood make the game scarcely worth the effort and cost?

In Chicago four large stores, depending primarily upon service for revenue, volunteered to serve as "test guinea pigs" in a market survey. Two hundred addresses of recent jobs were picked at random from their books and marks were placed on an outline map of the city at points corresponding to the location of these customers.

The map in these pages shows the graphic result. And in the following paragraphs are conclusions reached regarding methods by which each one of the four might conceivably increase sales without running operating expenses out of bounds.

* * *

Number 1 is the Fritzel Radio Laboratory. It is about a mile north of the well known "Loop," the business center of Chicago. Proprietor Joe Fritzel advertises extensively, using large space in the classified telephone directory, has several telephones spotted throughout the city although all activities center in the shop on the near north side. Direct mail in the form of postcard reminders is sent to a selected list.

The mapped analysis shows the tendency of people in this area to shop toward the loop area where the larger stores are located. The bulk of all calls are within a mile of the laboratory.

Ninety-eight per cent of the balance of the calls are north of Chicago's north and south dividing line. This means that nearly half of the area covered by the 'phone book is lost circulation, and intensified neighborhood advertising would be more productive.

Number 2 is the American Radio Labs, located eight miles south and a mile east of the loop in a good residential district near the campus of the University of Chicago.

Here again the firm's advertising is citywide, yet the bulk of the business is distinctly neighborhood. At this distance from the loop, there is less tendency to shop toward the city's business center, but a strong trend is evident in the number of service calls which are received three to five miles west of the shop.

W. C. Siegrist's firm could safely move westward and certainly it would pay to reduce citywide advertising in favor of a concentrated effort in the neighborhood and toward the west.

* * *

Number 3 is the Southtown Radio and Electric Service Company, which does no advertising, depending entirely on a large electric sign in front of the store on a very active business street nine miles south of the loop and a mile west.

Seventy-five per cent of Tom Hogan's business comes from a mile square area west of this shop, although the entire area around the shop should be equally productive. This indicates that neighborhood advertising might centralize this market to good advantage and bring in more business from the mile east of the shop as well as sustain the existing market to the west.

* * *

Number 4 is the Emergency Radio Laboratory which employs every available means of neighborhood promotion including a full page in a special 'phone directory covering an area about seven miles due west of the loop.

A natural barrier for John Beranich to the east about a mile is a large park, and a mile to the west is the city limits. This shop employs church and neighborhood newspaper

(Please turn to page 63)

RADIO RETAILING, OCTOBER, 1938

DOES BUSINESS PAY?

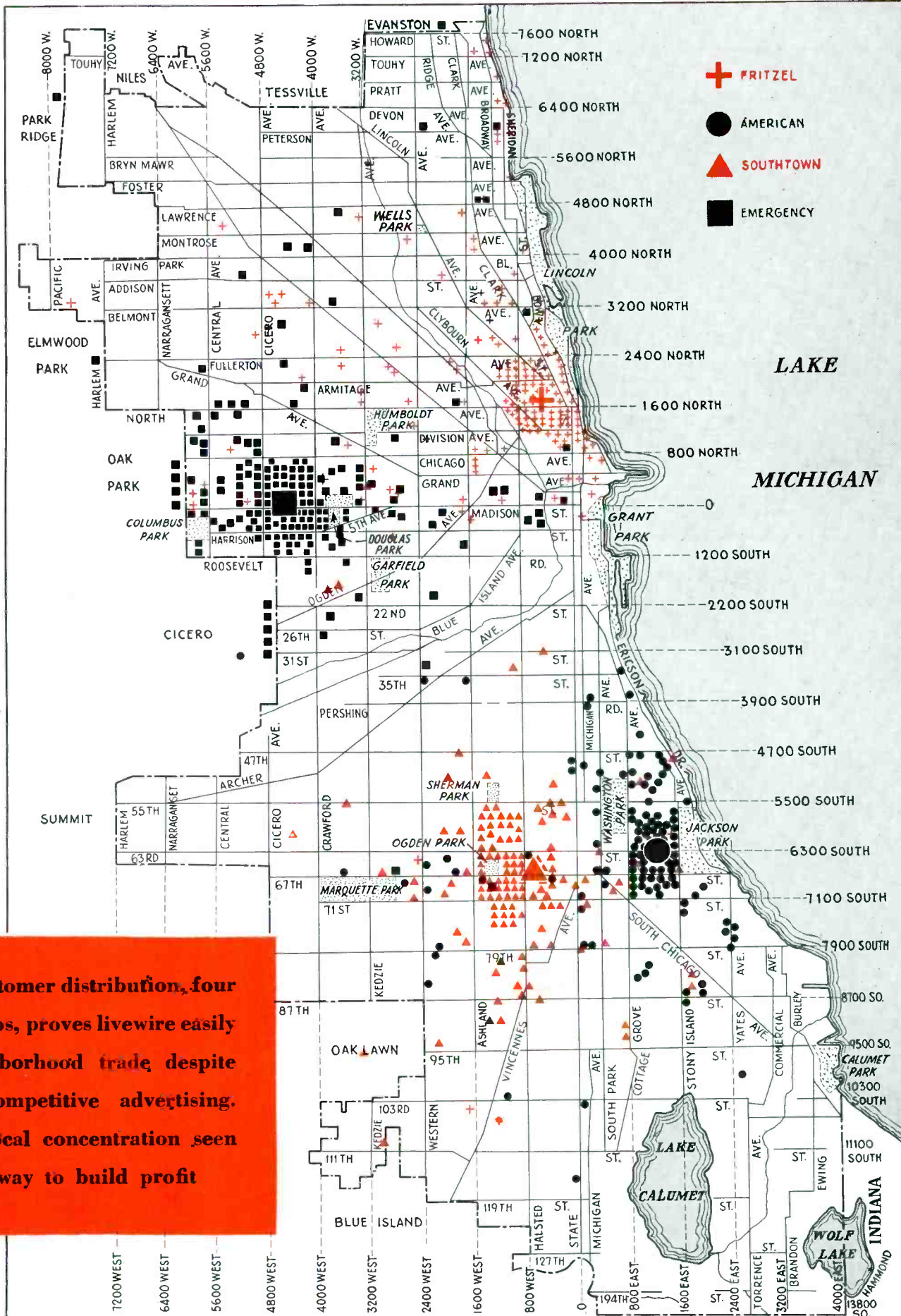

Study of customer distribution, four Chicago shops, proves livewire easily holds neighborhood trade despite city-wide competitive advertising. Increased local concentration seen as best way to build profit

TUBE CONTEST WINNERS

These four men collect *Radio Retailing's* \$150, offered for the best sales ideas to be used by retailers and servicemen

CLASS "A"

(For competing dealers, servicemen and employees)



← **FIRST PRIZE**
\$50

ARTHUR JOSEPHS
*Philadelphia Radio Service
Philadelphia, Penna.*

INDEPENDENT SERVICEMAN—"I have been in the radio service business about two years but my interest and experimentation go back as far as I can remember. I studied radio at the Philadelphia School of Wireless Telegraphy under Mr. J. C. Van Horn. Upon graduation I went into business with two fellow students. We began with absolutely no capital, but with plenty of ideas. We have spent these two years in building a solid foundation based on workable, progressive methods."



SECOND PRIZE →
\$25

WILLIAM J. BAUER
*Bauer Radio & Appliance Co.
St. Louis, Mo.*

DEALER—"Business established in 1903 by William J. Bauer, Sr., as a music store. Succeeded father in March 1927 and changed name, simultaneously changing from music store to radio and electrical appliances. Have specialized in honest service and prompt service, which has built up a steady stream of work in our shop. Our firm is now 35 years old and we have been located all this time in the same immediate neighborhood."

CLASS "B"

(For competing tube distributors and employees)



← **FIRST PRIZE**
\$50

L. W. HATRY
*Hatry & Young, Inc.
Hartford, Conn.*

DISTRIBUTOR—"I started in radio in 1918 at 15 years, was an amateur for several years under various calls. Came to Connecticut in 1924 to be QST department editor, then worked for Hartford Times. Have been commercial operator. Hatry & Young opened in 1928, entered wholesale parts and tubes a few months later and have been parts distributor for years now. Truck covers a large part of Connecticut and Hartford; New Haven and Bridgeport are served by stores."

SECOND PRIZE →
\$25

JERRY SHIREK
*Kaemper-Barrett Corp.
San Francisco, Calif.*



WHOLESALE SALESMAN—"I have been employed by Kaemper-Barrett for the past two years selling tubes to San Francisco dealers and servicemen. Left my job as serviceman for Byington Electric in 1927 and operated my own radio shop. I was active in the former Radio Dealers and Servicemen's Association, which successfully fought the free service racket in 1933. I served one year as vice-president of the Pacific Radio Trades Association."

JUDGES:

BOND GEDDES, Executive Vice President, Radio Manufacturers Association. JOE MARTY, Executive Secretary, Radio Servicemen of America, Inc. O. FRED. ROST, Editor, Radio Retailing.

(Contest started August 1
Closed midnight September 30)

HONORABLE MENTIONS

CLASS "A":

John T. Frye, Logansport, Indiana.

Michael Haddad, Detroit, Mich.

J. A. Mayr, Radio Doctor, Oroville, Calif.

CLASS "B":

Harold F. Jenkins, Fred C. Harrison, Elmira, N. Y.

Nicholas Friedl, The Dale Radio Co., Inc., New York, N. Y.

H. A. Eveleth, Wholesale Radio and Electric Supply Co., San Francisco, Calif.

WINNING PLANS WILL BE PUBLISHED IN THE NOVEMBER ISSUE

THE RADIO THAT ACTUALLY TUNES ITSELF!

*This Season's
Greatest Selling Feature*

Motorola WITH TIME-TUNING



Dealers all over the country are wild over it! TIME-TUNING tunes itself to all programs all day long! Now you can "pre-select", **hours in advance**, as many different programs as you wish, and then go away and forget your radio entirely. TIME-TUNING will remember for you. It **automatically changes station after station** without anyone even going near the radio. The last word in radio convenience!

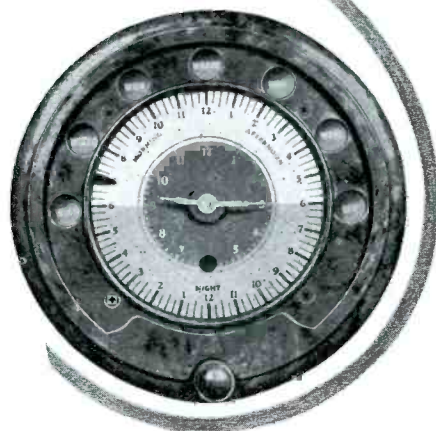

The Motorola TIME-TUNING Dial is easier to use than a telephone. With it you "pre-set" all the favorite programs you want at one time, and the synchronous self-starting, self-regulating electric clock changes each station, all day long without any attention whatever.

GALVIN MFG. CORPORATION • CHICAGO

MARKET IS ALL IN-DOORS — Eight Philco "Cool-Wave" units ranged along one wall of St. Louis University's chapel keep 200 people comfortable



Your answer may be . . . Air Conditioning

New package units respond to radio sales methods, also dovetail with refrigeration. Winter best time to select stock, start promotion

By FRED MERISH

IF you are a radio dealer looking for another product with which to smooth out the valleys in your year 'round sales curve, particularly if refrigeration has proven to be a profitable part of your operation, air-conditioning may be the logical line.

There'll be a lot of questions in your mind regarding this relatively new package product, and the following data gleaned from a survey of radio dealers already handling air-conditioning in the New England and Middle Atlantic States will provide many of the answers.

Air-conditioning equipment sales by dealers contacted increased 30 per cent in the first nine months of

1938 as against a similar period last year. Indications point to a steady climb upward for at least several seasons at this or a better rate. Units handled list all the way from \$175 to \$1,350, but the smaller units are definitely the best sellers at the moment. Dealers report the following breakdown of sales:

75 per cent to householders

20 per cent to offices

5 per cent to small stores

Seventy per cent of the units sold to householders were installed in bedrooms, because users want cool sleeping above all and because room coolers are often needed for sick people. Units with cooling capaci-

ties up to one ton usually suffice for homes. Many sales reported were to renters, who later became prospects for further purchases because the units may be moved as readily as radios. Doctors and dentists buy 45 per cent of the units sold to office occupants.

Units from 1 ton to 5 tons are usually sold for commercial operation. Restaurants, beauty shops, dress shops and specialty shops are the best prospects. Offices and stores are sometimes equipped with multiple installations, but dealers report that 95 per cent of all sales, including those to homes, cover single units.

Sales are divided about evenly between air-cooled and water-cooled units. Installation prices on water-cooled jobs run from \$10 to \$35. Usually 3 lines are run for water—supply, return and drain for condensation. Many air-cooled units need only a plug-in to the electric current, no installation charge, which listens well to certain prospects.

Air-conditioning is a good show-room seller. Dealers advise keeping units on display all year round so that in cold weather prospects can be built up for warm weather closing. (Waiting until hot weather to

(Please turn to page 63)

RECORDS for SOUND Work

Good amplifying equipment is only half the battle. A library of recordings will more than pay its way in rentals or sales

By ROBERT S. NASH

EVERY soundman has been puzzled at one time or another as to the correct choice of recorded music for use in conjunction with sound equipment. Yet every day more and more attention *must* be paid to recorded music because through its intelligent use *extra* rental installations may be secured.

A soundman's recorded music library can rival that of a radio station and still be held down to the minimum number of records and expense. If care and foresight is used in selecting a library, a representative list adaptable for any need can be assembled and maintained at a low cost.

Such a library is described herewith, was started when sound was in its infancy. Additions were made when required. It is sufficient for any music problem such as sound effects in plays and dramatic presentations, as well as for straight music amplification for dancing, etc.

Basically a recorded library for sound rental work consists of three separate classifications, namely: (1) Current and standard dance selections, (2) Classic and interlude music, and (3) Sound effects.

Picking Suitable Dance Bands

The current and standard dance selections need little explanation. However, to get the full advantages of such a library, the following suggestions may prove helpful.

A standard dance selection is one which is a favorite of years gone by and still keeps popular. For instance, "Alexander's Ragtime Band," "Tea For Two," "Twelfth Street Rag," "Marie," and others in this same line, are good bets for any sound library.

Experienced sound men are more and more turning to records that have a strong continuous musical background at all times. Selections involving single musical instruments and weak passages are being discarded in favor of the foregoing.

Everyone is "swing" conscious today. But if he considers the fact that four hours of straight swing-music will tire even the hardest jitterbug, the wise soundman will see to it that his library is selected

with some numbers that are not rendered in a swing version in their entirety.

Today, the practice of the larger soundmen is to play one orchestra for approximately fifteen minutes, which is equivalent to five average records. To explain better, suppose fifteen minutes are devoted to the music of Guy Lombardo, the next period to Benny Goodman, then Russ Morgan, Henry Busse, Eddy Duchin, etc. In this way the music being reproduced is relatively constant as to theme and tempo, which would not be the case if you alter-

nately played a Russ Morgan and Benny Goodman selection.

Good Interlude Discs

The classic or interlude music field has been given little thought by some operators. Yet practically every dramatic occasion could be the user of your service in this connection. As the selections never go out of date, the upkeep is small.

Its uses are to simulate dramatic scenes and provide specific music of a type in keeping with the presentation. For instance, dramatic plays
(Please turn to page 65)



MUSIC ON FILE—Steel racks house the author's discs. Here is one of them, in the sound equipment storage room

Perfect?

... They've Got to Be!

HERE you see just a corner of a typical Sylvania testing laboratory. In this room, highly skilled experts check Sylvania tubes for quality . . . record life tests . . . check engineering standards.

And Sylvania quality is *not* based on "averages". Each individual tube must

prove itself perfect—or be completely destroyed by the "crusher".

When you sell radio tubes, you can't afford to take chances with quality—it *means too much to your business!* Sell Sylvania and you can be *sure* of satisfied customers. For Sylvania quality is always A-1—protected by precision manufacture . . . proved by scores of tests.

SYLVANIA

SET-TESTED RADIO TUBES

Hygrade Sylvania Corp., Emporium, Pa. Also makers of Hygrade Lamp Bulbs.

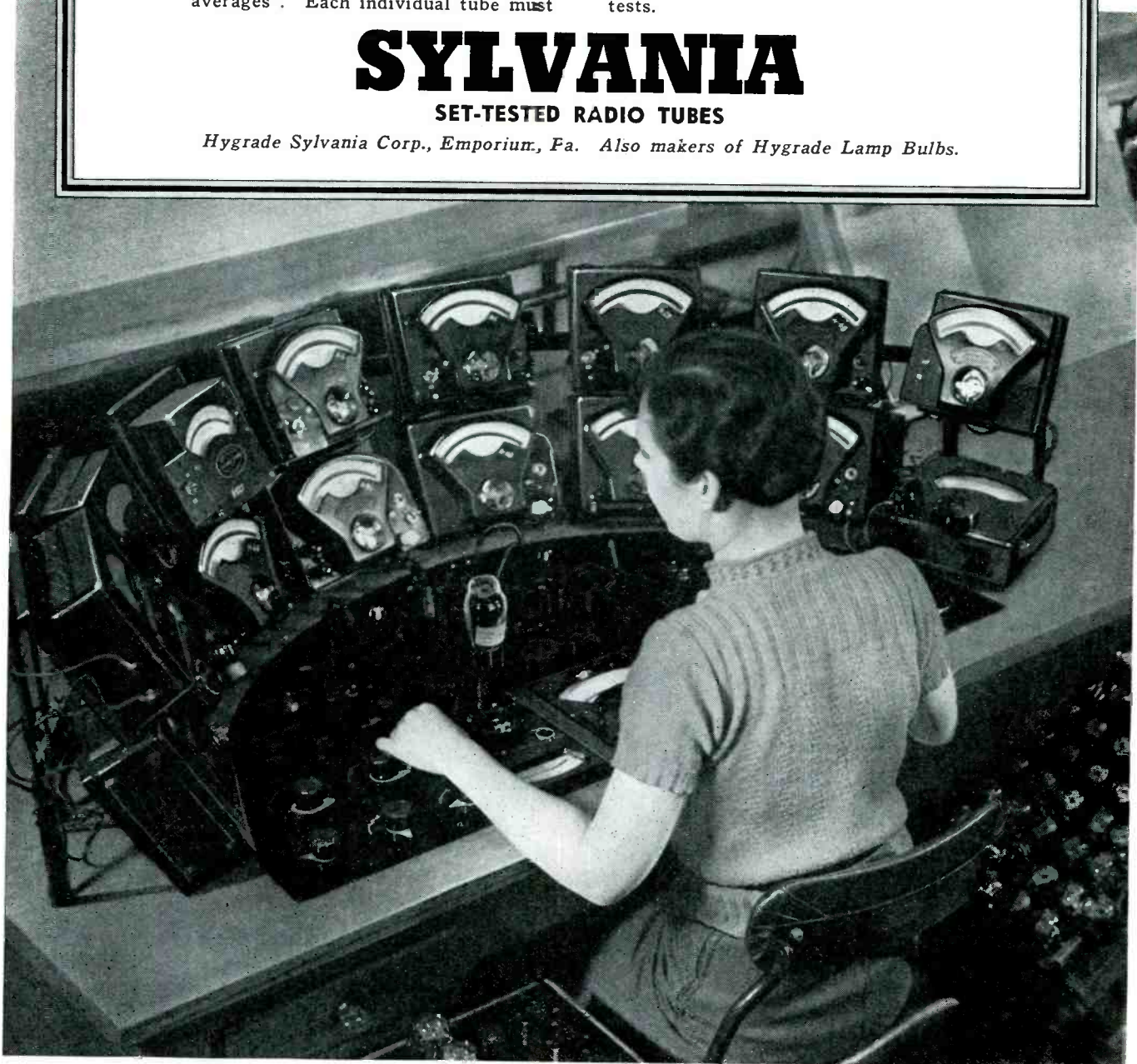

A black and white photograph of a hand holding a telephone receiver, with the receiver's mouthpiece pointing towards a tall radio tower. The scene is framed by a large, bright circular light source, possibly the sun or moon, creating a lens flare effect. The background shows a small building and trees at the base of the tower.

PUBLIC RELATIONS IN INDUSTRY

**A Presentation of the
Imperative Need of
Mutual Understanding
in the Conduct of Our
Daily Work**

**WITH SPECIAL REFERENCE TO
THE RADIO INDUSTRY**

An editorial service to meet Industry's Major Problem

T o t h e r e a d e r s o f R A D I O R E T A I L I N G

There is no doubt that today the American people are taking a keener, more critical interest in the conduct of business than ever before. And when I say critical, I mean exactly that. During recent years most of them have suffered loss, either of jobs or of savings, and under such circumstances men are prone to accept without serious question any scapegoat that appears plausible. In the confusion of fears and resentments, they seem to have concluded that shortsighted and selfish business management is chiefly responsible for their misfortune.

However mistaken and unfair such conclusions may be, management cannot ignore them. It must recognize that in the long run, the opinions of men are the result of experience, of what happens to them each day, much more than of what they are told.

Progressive management has already faced that fact; has already begun to think and work beyond the technicalities of production and distribution that once absorbed most of its energies. It sees more clearly and deals more proficiently with its human responsibilities. It is learning to reconcile the economic success of the industrial unit with the social welfare of worker and community.

Presently, every business—the small retailer as well as the large manufacturer—must learn how to interpret more convincingly to its own public the social as well as the economic benefits of its policies and accomplishments. Only as each business satisfies the newly aroused and critical interest of people in its affairs will it be able to disarm those who trade on the human tendency to blame our troubles on someone else. Yes, if business as a whole is to win a favorable public opinion, each and every business must act to improve its own public relations.

The readers of this journal, and of other business publications, compose, we believe, a group that can achieve for American business a sound and lasting solution of this vital problem. They alone are in position to shape the working conditions of 21 million employees. They alone can mould the attitude of those other millions who compose the various "publics" to which all business must be responsible.

Heretofore, the function of business papers has been to exchange successful experience; to dig up and disseminate practical facts for the use of their readers, serving primarily the technical and merchandising needs of business. But this matter of human relations has now become of equal importance, for good industrial and public relations, it has been found, reduces corporate losses, removes fear and suspicion, promotes operating efficiencies in both production and sales. A better knowledge of public relations technique is, therefore, quite properly essential for men in, or moving into, positions of greater executive responsibility.

So, beginning with this insert, each McGraw-Hill publication sets out to strengthen its editorial service in the important domain of Public Relations. I hope that the million readers of McGraw-Hill's business paper will get much real and practical help toward building better relationships between their own businesses and their employees, their customers, and the communities in which they must carry on.



James H. McGraw, Jr.

President, McGraw-Hill Publishing Co., Inc.

RADIO RETAILING

A MCGRAW-HILL PUBLICATION

WHY A PUBLIC RELATIONS PROGRAM

IN less than two generations the United States has changed from an agricultural to an industrial nation. Living standards and efficiencies at once the despair and envy of other countries have been created. Foreign delegations still flock to our shores to study our methods so that they may use them as patterns for their own organizations. Yet here at home today these methods and the systems responsible for them are under increasing attack.

Since every person employed in productive enterprise is a part of American industry, these attacks imperil the livelihood of nearly forty million workers and their dependents. The newest addition to the payroll has as much—if not more—at stake as the veteran business executive. That also is true of particular industries which at present may not be under direct fire. All industry is so interrelated and interdependent that even the seemingly immune enterprise must suffer when the legitimate activities and the buying power of their customers, or the customers of their customers, are curtailed.

Ironically enough, public acquiescence in many of the current attacks is an indirect recognition of the satisfactory manner in which our industrial system normally functions. Reasonable opportunities for the employment of those ambitious to put their mental or physical talents to work, and continually rising standards of living have come to be widely accepted as a matter of course. Any unfavorable change in these conditions leaves the general public surprised, confused and resentful. Such reactions as these make it easy for pressure groups to unloose destructive propaganda which further heightens resentments and breeds new misconceptions.

These misconceptions take many forms shaped by the experience, the inexperience, or the special interests of the critics. To one it appears that business can't manage itself and must be owned and managed by the Government. Another believes that employees are underpaid or that stockholders and executives are overpaid. To others corporate surpluses are too high. Many have convinced themselves that power and machines have reduced employment oppor-

tunities; and that industry can raise wages and reduce prices while costs go up.

Several misconceptions are based on faulty generalizations. Because a few companies have been remarkably successful, it is argued that all could make money. Because some corporations have been ruthless, all corporations, it is contended, will stoop to unethical conduct to gain their ends. This is like saying: John Smith killed Bill Brown; John Smith is auburn-thatched; all redheads, therefore, are murderers. Unfortunately, those who would indict all business for the crimes of a few are more subtle in their approach and so create an impression not in accord with the facts.

To put it bluntly, American industry, once so highly praised for its contributions to the national well-being, is now on the spot. Prevailing misconceptions of how business operates and what it does have made a field day for those who propose to hamstring or destroy private initiative and individual opportunity. These proposals run a broad gamut: They include public ownership, increasing and rigid federal control at the expense of local autonomy, ill-conceived legislation on hours and wages, labor dictatorships, and confiscatory taxes on thrift and employment security.

While the man in the street may be criticized for his willingness to swallow these nostrums, he is not wholly to blame. Industry, too, has been at fault, in assuming either that he was fully informed on those phases of its operations which are properly a matter of public interest, or that a healthy curiosity should be discouraged. Misconceptions multiply where the facts are hidden.

The tragedy of the situation lies in the fact that it might easily have been avoided. In the simple days of local and localized industry, everybody connected with a particular enterprise knew everybody else connected with it, and the details of its operations were an open book. The boss and the employees were neighbors; the customers, for the most part, fellow townsmen. Outside purchases were limited largely to those products which the local community

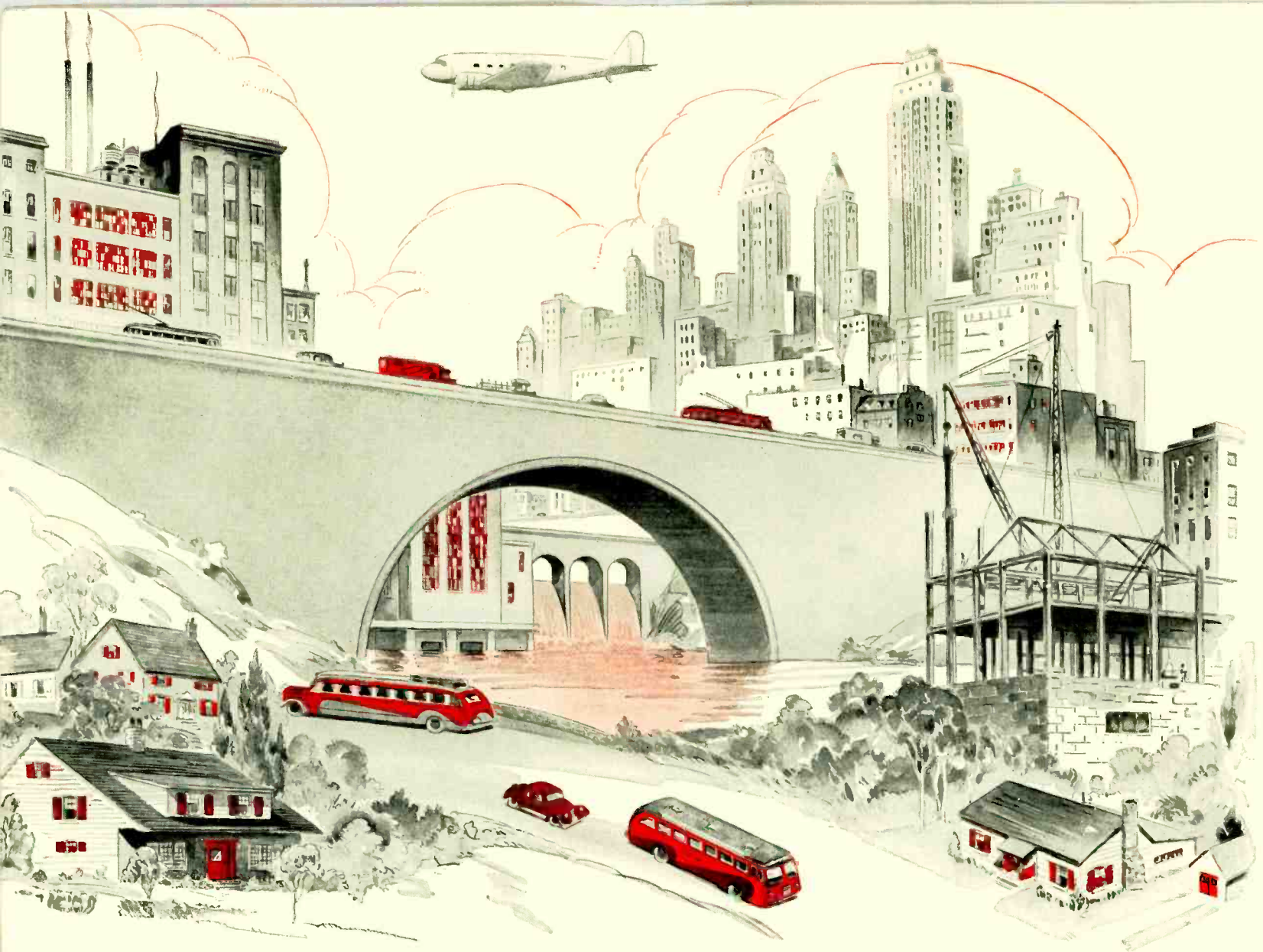

neither manufactured nor raised. Competition in the modern sense was practically non-existent.

As industry developed and enlarged its field of operations, much of this early intimate personal touch was lost. The small enterprise grew bigger. In some cases combinations took in the local business and financial control passed out of the community. The local industry which still retained its identity was busy meeting increased competition and seeking to expand its distribution. Little attention was paid to changing conditions that were fostering misconceptions about the personal relations of the business. Bit by bit the close acquaintance and familiarity of the early days disappeared.

Common understanding of these things also was impeded by the greater variety of occupations as industry expanded. Each man's job became so highly specialized that the old feeling of common partnership in a joint undertaking frequently was buried in an exaggerated feeling of the relative importance of his own work. This made it easy for each occupational group to get the idea that its contribution to the undertaking alone was essential and that many of the other groups were parasitic or, at best unimportant.

Such mistaken beliefs are the exclusive property of no particular group. "Goods are valueless until sold," chants the sales staff; "without us the wheels of industry would cease to turn." "The wheels would turn much faster" growls the production department, "if we didn't have so many

lame-brains drawing fat salaries as salesmen." Under the cold glance of both groups, the clerical force heatedly inquires: "How long do you think this business would last if we didn't keep the cost records, send out bills and collect the money for pay checks?" Some executives and engineers, too, have been known to forget that their plans cannot be carried out without the cooperation of other groups.

Possibly the greatest single cause of misunderstanding and friction has been fuzzy thinking on social responsibilities. Many of the responsibilities which rested on the individual or the state in our fathers' and grandfathers' days have been shifted to the shoulders of industry. New ones constantly are added or proposed—often before industry has had time to adjust itself to those which have gone before. Some of these responsibilities affect employee relations; others involve customer relations. The worker, for example, no longer is completely defenseless against the occupational hazards of his employment. "Let the buyer beware" no longer is considered smart merchandising. Many of the changes now embodied in the laws were anticipated by industry itself. Opposition—valid or otherwise—to social legislation, however, has been used to damn business in the public eye.

Fortunately, the barriers to good will and common understanding can be broken down. The process is a simple one. It consists chiefly in maintaining good policies in

human relationships and in keeping all interested people—employees, stockholders and their neighbors, customers and the general public—informed. It means telling them in plain terms what revenue is received and where it comes from, what revenue is paid out and who gets it, how an industry serves the individual, the community and other industries. Finally, it includes the acceptance of the social responsibilities which the advance of civilization imposes upon business.

Add all these things together and you have public relations.

Most employers are willing to accept their social responsibilities, but they are inexpert in making that acceptance articulate. Too many employers have failed to make clear their policies, their practices and their purposes as they relate to fair dealing with employees, investors and the general public. Their intentions have been good, but they have cloaked them with a veil of secrecy and made a mystery out of simplicity. As a result the uninformed have been given a royal opportunity to exercise their imagination. And they have done it!

Public relations is a comparatively new activity for most business enterprises and involves a technique which too many have not yet learned. Obviously, the first place for each company to start is within its own organization. This is the "inside job" that builds a company's good name among its own family and lays the firm foundation for building public confidence and favor. As one exponent of the art phrases it: "Industry's public relations cannot be

one thing and its private actions and policies something else. The two must be in complete accord."

The inside job should present no real difficulties to fair-minded employers. Most workers have a normal predisposition to view in a favorable light the organization in which they earn their livelihood. Most companies endeavor to conduct their operations so as to justify that favorable attitude. But too few of them are adept at dramatizing the facts that furnish a substantial basis for maintaining employee good will. So, where misunderstanding and suspicion born of ignorance exist, time may be required to break down the barriers that have grown up.

The task of telling this inside job to the outside world, however, will not be easy, for two reasons. First, it has been so long neglected that the backlog of misunderstanding is large. Second, public relations involves attitudes as well as actions, a viewpoint as well as an organization. Public relations is not a commodity that can be purchased like a car of coal or a bolt of silk; neither can it be sold by "canned" material. Each program to establish sound public relations must be individualized and indisputably stamped with the personality of the company promoting it. *And the deed must always back the word!*

But the task is worth the effort. For, with the inside job right, a properly conceived and intelligently executed public relations program offers business the means of successfully counteracting unjust public suspicion, unfair political attack and unwarranted outside dictation. The need is urgent.

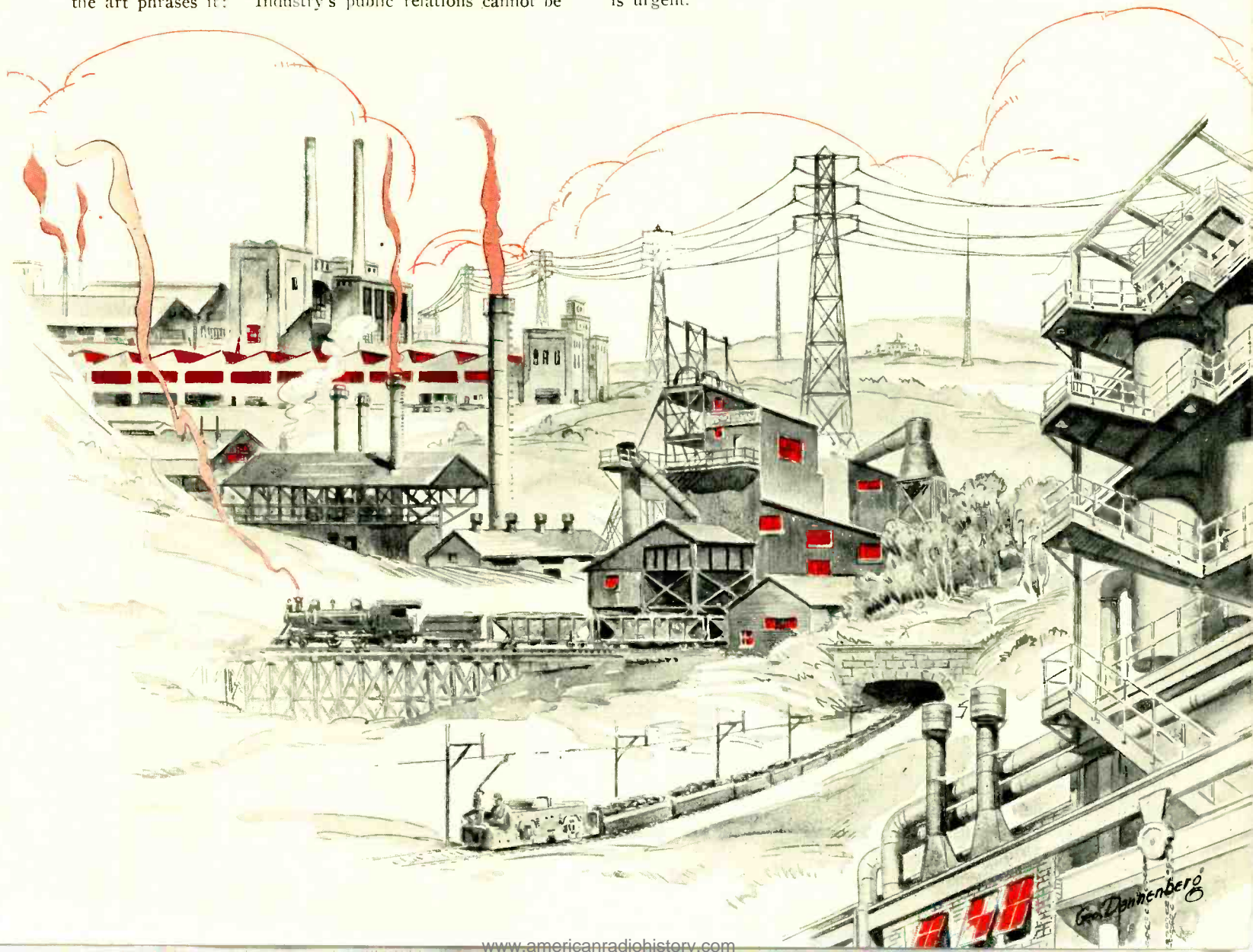

T H E *R* A D I O

By O. FRED. ROST

PARADOXICAL as it may appear, it is true nevertheless, that the radio industry, founded as it is upon civilization's greatest and most efficient medium for direct and instant communication with the masses, has used its own vehicle rarely or not at all in building and fostering in the minds of the masses a true and continuing appreciation of the precious privileges through which its universal enjoyment is made possible.

The man, woman or child of 1938 turns the dials or pushes the buttons of a radio set with as much matter-of-fact expectancy of program reception, as they turn the kitchen faucet and confidently know that water will flow. This despite the fact that the world has had water works ever since the dawn of the Christian Era, while radio is only 18 years old.

That the radio industry has succeeded in building for itself so secure a place in the American scene in so short a space of time is a tribute indeed to the engineering genius that created its products and the commercial talent that found ways and means of making those products available to the masses.

That it has failed to dramatize its free offerings effectively, has failed to keep before the masses those significant factors, methods, policies and procedures that form the vital and indispensable foundation for all its accomplishments, is unfortunate.

It would be difficult to say just who, or which branch of the industry is responsible for that failure, but few, if any one will say that it does not exist. Nor will anyone dispute the fact that current events and trends have disclosed many sound reasons why radio's policy of studied inertia, so long pursued, must be changed. It would be unfortunate indeed if the public were allowed to assume toward radio that same matter-of-fact acceptance, which it is prone to assume all too rapidly with regard to any new convenience and has in fact assumed toward such relatively new contributions as electric light, good roads, speedy transportation, the moving and talking pictures.

Such state of complete public acceptance might be a welcome achievement indeed, if the products of the radio industry could be merchandised like other commodities where every sale is final and where after the purchase the privilege of determining the extent of its enjoyment or use is vested wholly in the purchaser, for instance as is the case with the automobile.

When the consumer buys an automobile, he gets an inert mass of metal. It is completely and continuously within his control as to how long that mass of metal shall be transformed into a mobile vehicle. He himself must buy the gasoline which makes it go. He can go when and where he chooses, as fast or as slow as he pleases, and he can replenish his supply of gasoline at every cross road, in any quantity, at any time, always at his pleasure and expense.

Contrast with that the case of the radio set. It too is an inert mass of metal, but its purchaser cannot buy the broadcast sounds which give it life at his own convenience or pleasure. Indeed, the American owner of a radio set *does not expect to buy* the broadcast sounds which make his set useful, but instead he expects to get them *free*—today, tomorrow and forever.

To the radio industry the existing public expectancy of programs that come free of cost to the listener, that are broadcast by free and privately controlled stations, free from governmental interference or censorship, constitutes an immensely valuable and indeed precious but inadequately appreciated bulwark against any open or concealed attempts to interfere or substantially reduce that state of freedom through which the universal enjoyment of radio has been made possible in the U. S.

Indeed, that public expectancy has created a definite and undeniable state of partnership between the public and the radio industry, in that upon the freedom of its enterprise rests at once the ability of the industry to produce at low cost the world's finest receiving sets and highest class programs as well as the public opportunity to enjoy those offerings.

Although that partnership has existed for many years neither the industry nor the public have been potently conscious of it, so that few if any attempts have been made, to create and foster better public understanding of its existence and of the precious privileges which it enfolds. The radio industry has allowed its public relations to drift whither they might.

In Part I of this insert are enumerated some of the conditions and events, encountered during the last few years which make it apparent that not a single American industry can afford to neglect its public relations, unless it be willing to put in jeopardy its independence, even its very existence as private enterprise. That being the case, the radio industry, involving as it does the world's fastest means of communication simply DARES NOT place its freedom and future in jeopardy.

In that direction already some ground has been lost, witness: the 5 per cent excise tax *that is now imposed* on radio sets AS A LUXURY (along with fur coats, perfumes, cosmetics). More ground will be lost, if certain plans actually suggested in certain government departments are carried through.

If it seems reasonable that resistance should be offered to further invasion, the industry will need the support and cooperation of an understanding and sympathetic public. To create that sympathetic understanding the industry must plan and put into execution a comprehensive, coordinated, cooperative program for building better public relations.

While it is not the intent of this presentation to project a detailed plan of procedure, it seems desirable to point

INDUSTRY'S **J**OB

out that any program for building better public relations for the radio industry may quite properly prescribe definite activities for members of every important functional group, including the following:

1. The manufacturers of radio sets, parts, accessories.
2. The manufacturers of sound equipment and phonograph records.
3. The broadcasting stations.
4. The advertisers who use radio.
5. The wholesale distributors of radio and allied products.
6. The retailers.
7. The radio servicemen.
8. The salesmen employed by wholesalers and retailers.

Since no two of these groups will contact the public under identical circumstances, it will be necessary to vary the materials and media that are employed to bring pertinent information to the attention of the public.

Here are outlined briefly some of the ways and means that may appeal to members of the different industry groups in promoting good will.

THE MANUFACTURERS

Obviously a manufacturer will want to start his public relations work right in his own establishment and among his own employees. Probably he will want to disseminate facts and figures that will give workers a better understanding of the whole structure of the radio industry and of the problems with which their employer must struggle.

He will want his workers to gain such pride in their jobs and in their being identified with the radio industry, that they will enjoy talking about its achievements in their contacts with the public and that they will be eager to explain just how it differs from radio as it is handled in other countries.

Aside from organizing his own employees into a militant group of well-informed radio boosters, the manufacturer will find it desirable and profitable to provide the necessary publicity materials for a campaign to enlist his distributors and dealers in the cause.

THE BROADCASTERS

The broadcasting stations may want to assign some definite periods of their sustaining programs to a series of dramatizations of important events and incidents in the history of the radio industry. Such features may quite properly be followed by a series of presentations of significant facts and figures on radio in the United States and a series of comparisons of radio as a free enterprise and radio as it is shackled in other countries.

It would be desirable for broadcasters to establish suitable channels, through which knowledge of forthcoming programs of that type may be publicized and merchandized in advance by other groups of the industry.

SPONSORS OF BROADCASTS

It is recognized that not all products advertised on sponsored programs lend themselves to a tie-in with a public relations theme. However the history of commercial broadcasting has recorded hundreds of instances where lives and property were saved directly or indirectly with the aid and cooperation of advertisers. The dramatization of such happenings in the style of the March of Time would prove undoubtedly popular and build greater public appreciation of radio.

THE DISTRIBUTORS

Properly primed and supported by the manufacturers whose goods they sell, the wholesale distributors could function as territorial headquarters for disseminating pertinent information and distributing suitable printed matter to local organizations, service clubs and of course to the retailers.

THE RETAILERS

Through effective effort on the part of distributors and their salesmen, every retailer who sells radios should be made conversant with the broad principles underlying the American radio industry. He should be made to appreciate that he himself has an important stake in the present set-up, and that he should take an active part in making his customers consciously aware of the privileges now enjoyed.

Retailers should be induced to capitalize their daily contacts with the public to the utmost in building sympathetic understanding and good will toward the whole radio industry.

THE SERVICEMAN

Being basically a trouble-shooter and gaining his contact with the public only when help is needed, the serviceman can be made one of the most important factors in creating greater understanding and appreciation of radio.

CONCLUSION

It is appreciated that much of the material that various groups of the radio industry may wish to use or prepare for the purpose of building better public relations, will have to present some facts and figures that will create interest in and give authority to such presentations.

To make available that type of factual data, the following pages are included in this presentation.

RADIO RETAILING will gladly render additional assistance to any individual concern or group, interested in preparing a comprehensive plan or program with the objective of building better public relations for itself and/or the radio industry.

RADIO...THE

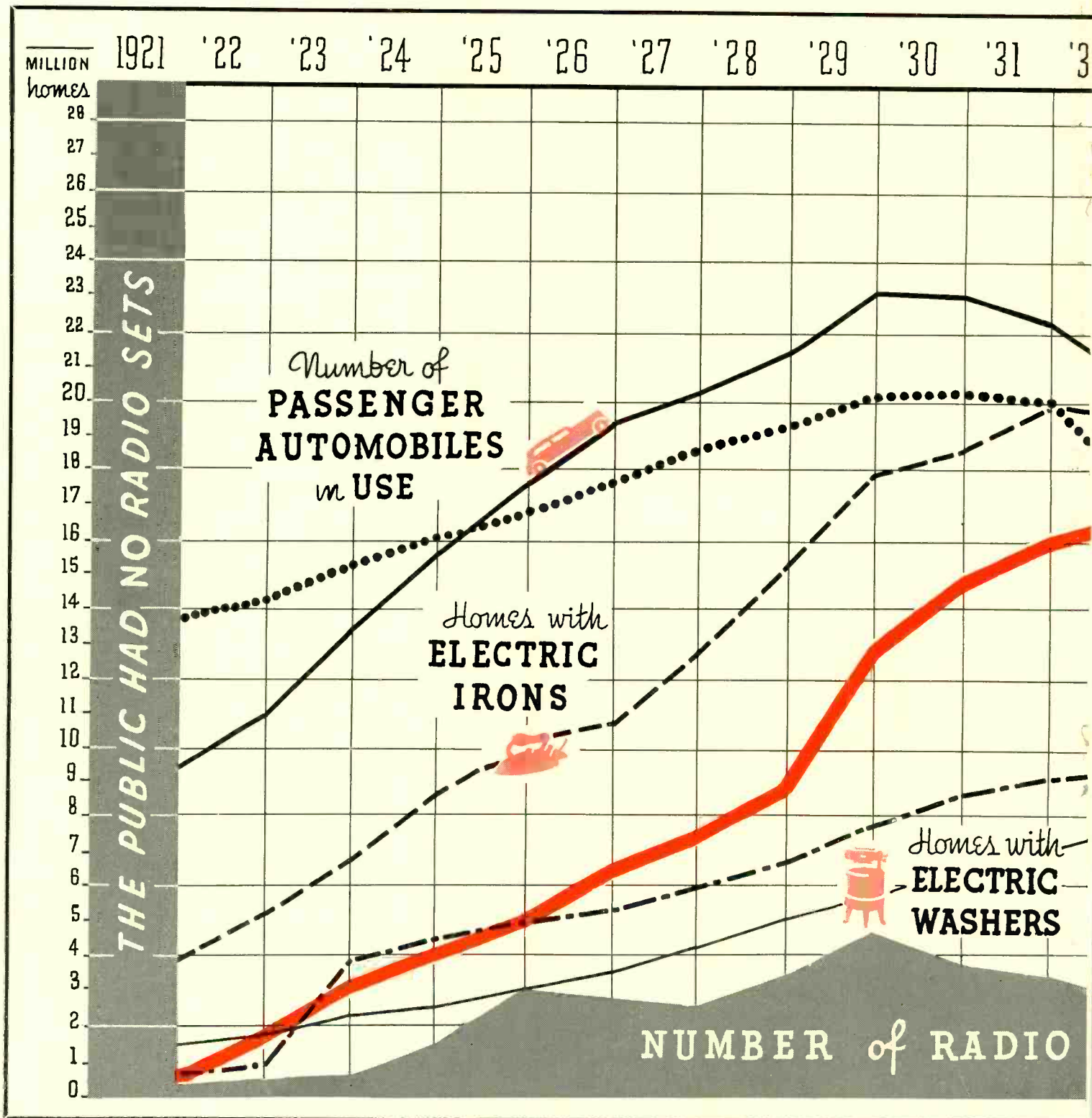

RADIO RETAILING ©

Y O U N G E S T I N D U S T R Y

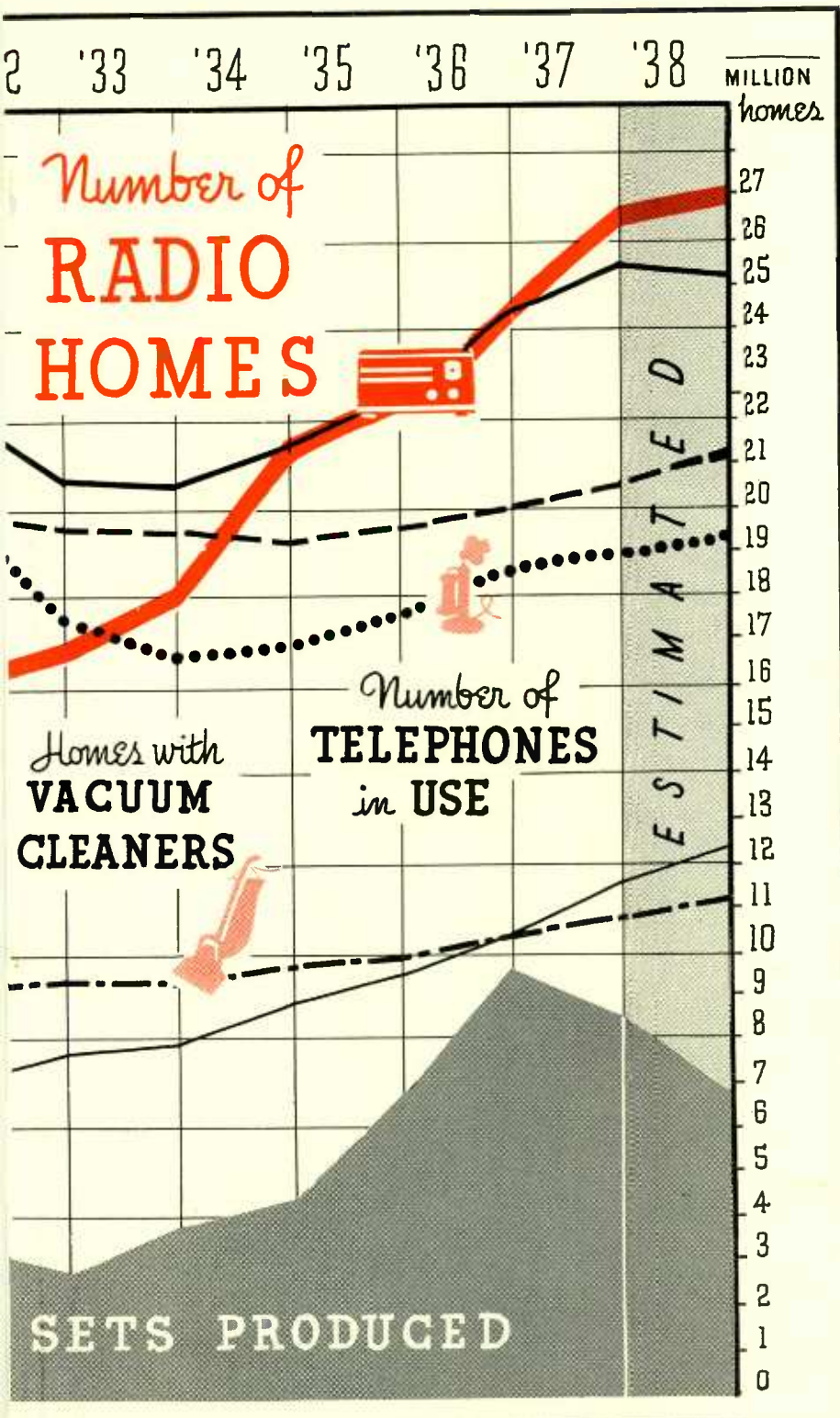

*has out distanced
all other of the
new Twentieth
Century Indus-
tries in reaching
into the largest
number of Amer-
ican Homes*





Cost
\$275.

▲
1923

TYPICAL INSTALLATION

- 4-Tube Regenerative or TRF Receiver
- External Horn (extra)
- Tubes (extra)
- Dry or Storage "B" Batteries (extra)
- Storage "A" Battery (extra)
- Battery Charger (extra)
- Interconnection Wires or Cable (extra)
- Cabinet In Which To House Set and Extras

***R*adio prices have gone **DOWN** steadily**

Radio manufacturers, through expensive research, have improved the design and performance of sets and refined their methods of production, so that the difference in the type of sets and their cost to the consumer has produced an almost unbelievable contrast between 1923 and 1939

Despite the Wide Difference in Price There Is No Comparison with respect to

**TONE . . . APPEARANCE
CONVENIENCE . . . RANGE
RELIABILITY . . . LONGEVITY**

-
- 8-Tube Superheterodyne *including*
 - Built-In Dynamic Speaker and Baffle
 - Multi-Purpose A.C. Tubes
 - Complete, All-Electric Power Supply
 - Push-Button Or Other Automatic Tuning
 - Allwave Reception
 - Chairside Convenience
 - Cabinet Equal to the Best Furniture

▼
1939

MODERN RECEIVER

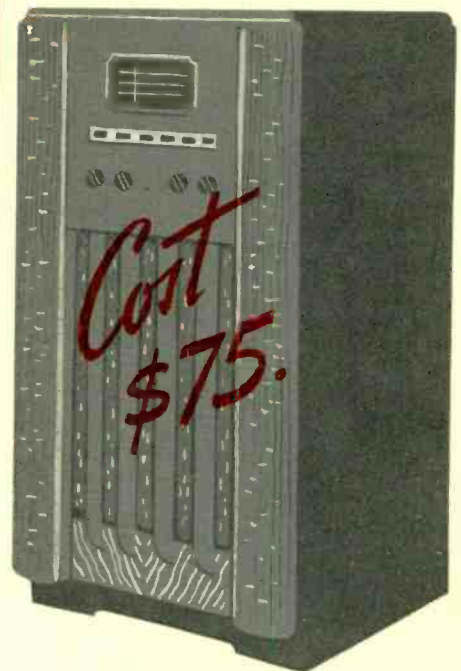

Cost
\$75.

***R*adio values have gone **UP** faster . . .**

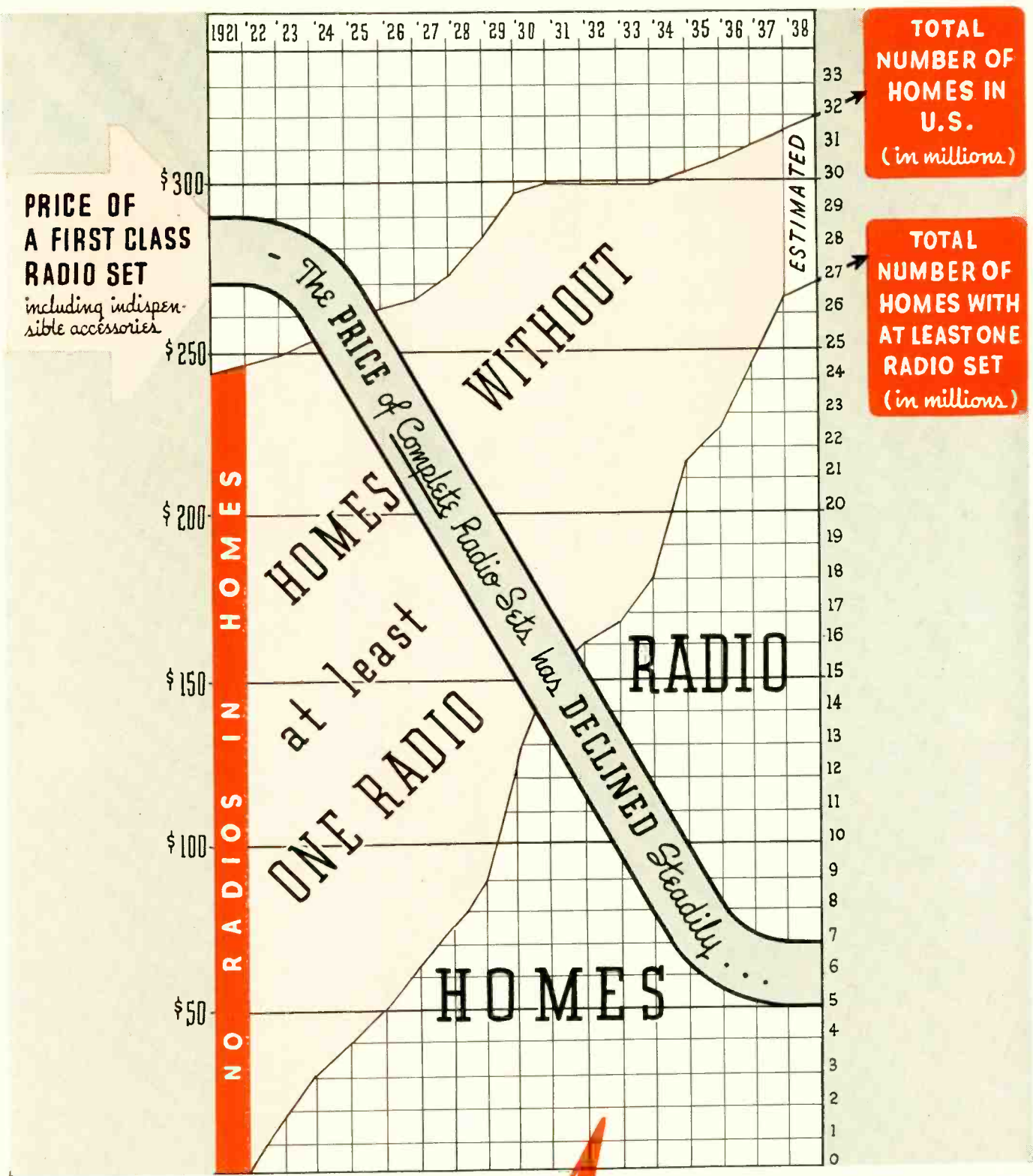

A **AMERICA'S**

No. 1 ENTERTAINMENT

RADIO RETAILING ©

RADIO AIDS

Radio set and parts manufacturers draw on every important industry for materials. For producing a single finished modern set it requires the following:

144 DIFFERENT RAW MATERIALS
3,977 FEET OF WIRE ($\frac{3}{4}$ OF A MILE)
213 SEPARATE SOLDERED JOINTS

Here is a partial list of materials:

CHEMICAL

Ammonium Chloride
Arsenic Trioxide
Barium Carbonate
Barium Nitrate
Calcium Oxide
Cobalt Oxide
Ethyl Alcohol
Glycerine
Latex
Lead Oxide
Magnesia
Nigrosine
Orange Gum
Potassium Carbonate
Resin
Shellac
Sodium Carbonate
Sodium Nitrate
Stearic Acid
Strontium Carbonate
Strontium Nitrate
Thorium Nitrate
V.M.M.P. Naptha
Xylol
Zinc Chloride
Zinc Oxide

METAL

Aluminum
Barium
Cadmium
Calcium
Chromium
Cobalt
Copper
Iridium
Iron
Lead
Magnesium
Mercury
Misch. Metal
Molybdenum
Monel
Nickel
Phosphor Bronze
Platinum
Sheet Iron
Sheet Steel
Silver
Strontium
Tin
Titanium
Tungsten
Zinc

MISC.

Adhesive Tape
Asphalt Compound
Bakelite
Bond Paper
Borax
Bus Wire
Carbon
Felt
Glass
Glue
Gum
Ink
Lacquer
Lava
Linen
Mica
Micarta
Paraffin
Petroleum
Porcelain
Rubber
Salt
Soap
Staples
Veneers
Wax
Wood

OTHER INDUSTRIES

COAL . . . OIL . . . COPPER . . . RUBBER . . . MACHINERY
TRANSMISSION EQUIPMENT . . . TRANSPORTATION

All Benefit from Radio

The use of radio in the home has become an important load factor of the electric light and power companies, thereby directly increasing the consumption of and broadening the markets for coal, fuel oil, transmission and maintenance equipment and increasing the tonnage handled by railroads and other common carriers.

This chart shows how **RADIOS'** use of Electric Current has grown

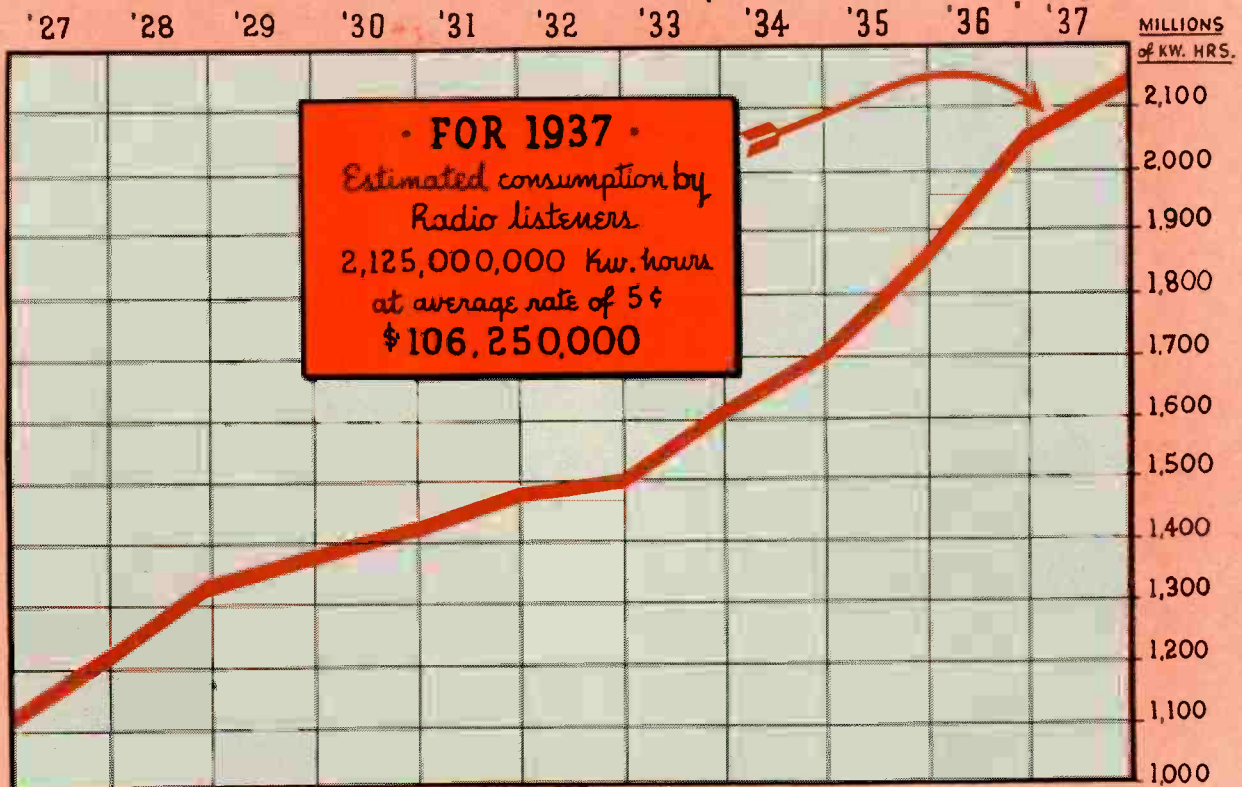

N O L I C E N S E S **T** O **B** U Y

Freedom of individual enterprise and freedom from licensing restrictions and governmental censorship have enabled the United States to *lead the world* in carrying the benefits and blessings of radio reception into the home.

NUMBER OF RADIO SETS IN USE VERSUS POPULATION

COUNTRY	POPULATION	RADIOS IN USE	RATIO
UNITED STATES	130,000,000	37,000,000	1-3½
Sweden	6,233,000	1,026,000	1-6
Denmark	3,706,000	673,000	1-6
Germany	66,000,000	8,000,000	1-8
France	41,834,000	3,916,000	1-10½
Argentina	12,561,000	1,000,000	1-12½
Japan	70,000,000	2,593,000	1-28
United Kingdom	486,726,000	10,000,000	1-48
Italy	42,527,000	800,000	1-53
Mexico	16,552,000	250,000	1-64
Brazil	45,000,000	400,000	1-100
Russia	165,000,000	350,000	1-470

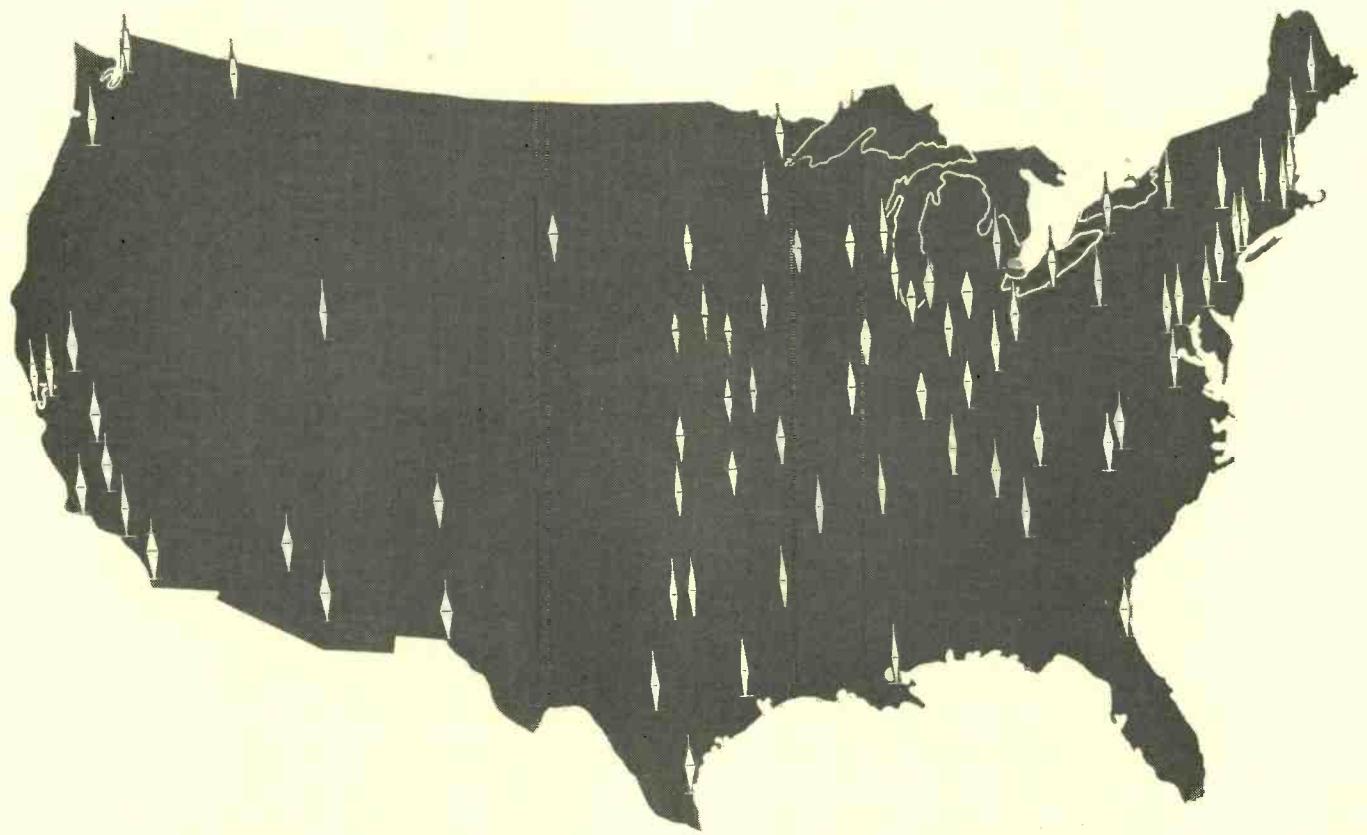

**THE *B*EST THINGS
IN LIFE ARE *F*REE**

TO PROVIDE FREE BROADCAST PROGRAMS for America's 37 million radio sets the broadcasting industry received advertisers' support in 1937 equal to

\$225 EVERY MINUTE

\$13,460 EVERY HOUR

\$114,222,000 FOR THE ENTIRE YEAR

With the world's finest programs produced by the world's best talent, crowding all channels during all hours of the day and night, the American listener did not pay one penny to obtain the benefits of radio whenever it wanted them.

RADIO RETAILING ©

72,865,000 PEOPLE

Radio Touches Their Lives Daily

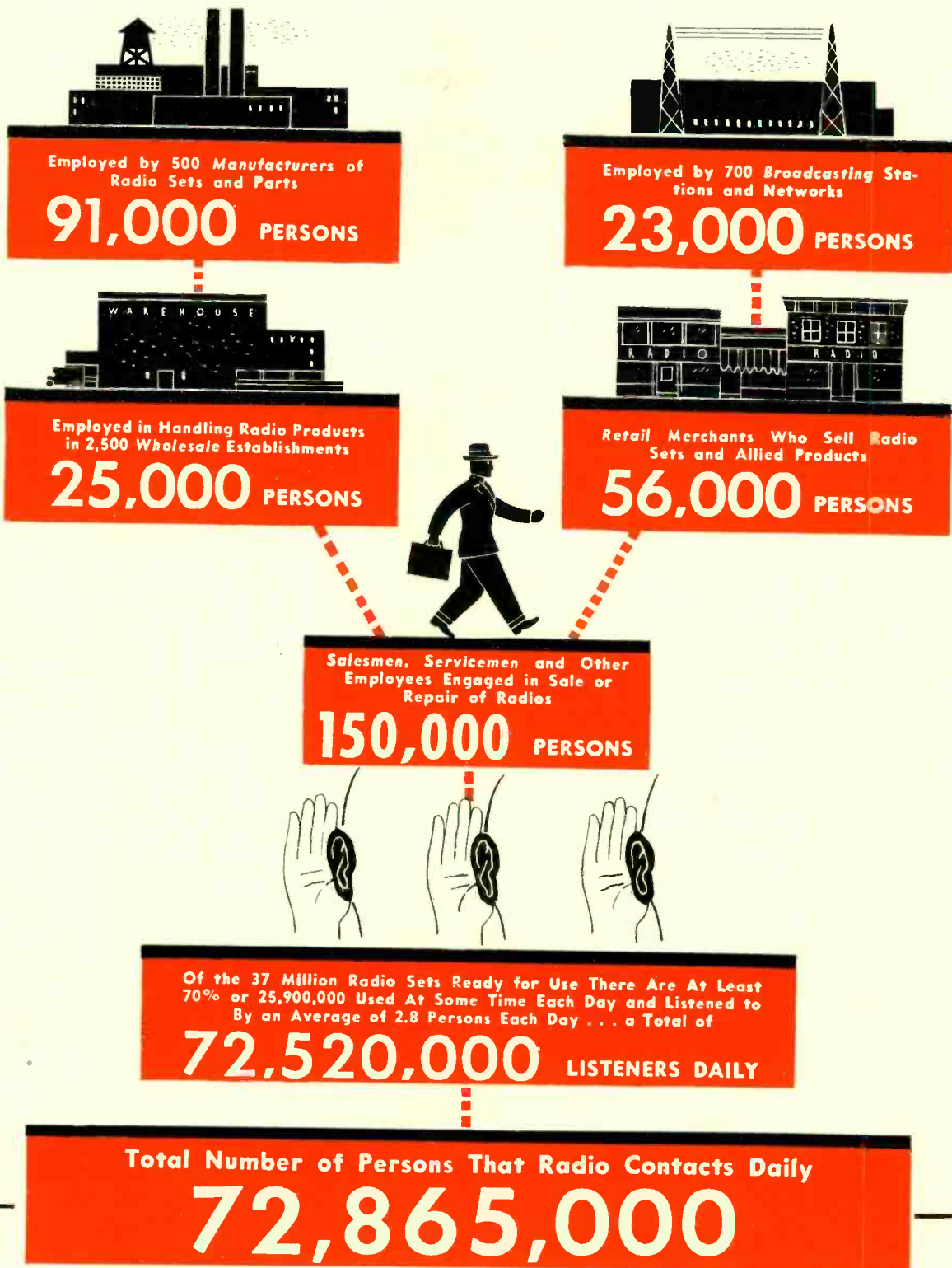

RADIO RETAILING ©

NEW 1.4 VOLT TUBES?



Here's the Power You Need for Them

A Life-Protected DRY "A" Battery That Gives 1075 Hours of Service

A great new market opens up to you with the introduction of the new low voltage tube. There are many surprising new possibilities for portable sets—new economies for farm radio.

You'll be ahead of the game—realize real profits—if you're ready to meet the demand for 1½ volt portable power.

Stock and sell dry batteries by Burgess. They're light in weight—small in size—LONG in service, because their active life is prolonged by "CHROME"—the exclusive Burgess ingredient. They have all of the stamina and dependability that have made Burgess the choice of leading explorers and scientists. They're engineered to meet these new 1.4 volt requirements.

Profit with Burgess batteries—send coupon for information.

YOU SHOULD KNOW ABOUT THE BURGESS BATTERIES

For 1½ Volt Portable Sets

- A—No. 4FA—a 1½ volt dry A battery. Rated 40 watt hours. Screw terminals.
- No. 4FAPI—a 1½ volt dry A battery. Rated 40 watt hours. Plug connections.
- B—No. 5308—a 3 pound, 45 volt B battery with binding post terminals.
- No. 5308-PI—a 3 pound, 45 volt B battery with plug connections.
- No. B30PI—a 3 pound, 45 volt B battery suitable for Philco portable. Plug connections.

A & B Packs

- No. 6T-A60—a combination 1½ volt A and 90 volt B in portable size. Weight 5¼ pounds. Plug connections.

For 1½ Volt Farm Sets

- A—No. 20FPI—a standard 1½ volt dry A. Plug connections. Approximately 1075 hours at 0.2 amp drain.
- No. 16GPI—a dependable 1½ volt A battery for Philco 1½ volt sets.
- B—No. D60—a standard 90 volt B. Plug connections. Approximately 1000 hours of service on most 1½ volt sets.
- No. D60PI—a dependable 90 volt B battery for Philco 1½ volt sets.

A & B Packs

- No. 17G-D60—a combination 1½ volt A and 90 volt B. Suitable for Sentinel and certain other 1½ volt receivers.

for INFORMATION

Burgess Battery Company
Freeport, Illinois

Please rush complete information about Burgess batteries for the new 1.4 volt tubes.

Name.....

Company.....

Address.....

Town.....State.....

BURGESS

CHROME-PROTECTED RADIO BATTERIES

FIFTEENTH BOARD of DIRECTORS R.M.A. 1938-39



Man Bites Dog

Dealer association president says chains, department stores adhere more rigidly to Fair Trade laws than independents

BROOKLYN, N. Y.—First business of the Electrical Appliance Dealers Association of Brooklyn, Inc., held here September 28, was an outline of the progress of the Feld-Crawford act in the area by Percy Peters. Contrary to general belief, according to Peters, chain and department stores were adhering quite closely to the provisions of the act while a survey indicated that many independent dealers were still beyond its pale. At least 200 violations by dealers were cited in the report.

Announced was the appointment of member Bolger to the association position of executive secretary, soon to be a full time job. To secretary Bernhard, who has given part of his time to these duties for the past six years, went a rising vote of thanks. Bernhard will continue as honorary secretary until the completion of his elective term.

Representatives Elect

Bittan, Forshay, Sonkin head active group

NEW YORK—At its opening meeting for this fiscal year, held September 13, "The Representatives" of radio parts manufacturers elected the following officers for the 1938-1939 season:

President, D. R. Bittan; Vice-president, John Forshay and Secretary-treasurer, David Sonkin.

Board of Governors includes: Perry Saftler, Chairman; Adolph Friedman, John DiBlasi, LeRoy Schenck and Leo Freed. Membership committee: John Forshay, Chairman; John Kopple,

Adolph Friedman, Perry Saftler and I. Golden. Entertainment committee: Matthew Camber, Chairman; C. B. Cooper and Jules Sussman.

Barter And Exchange

Illinois dealers association tries novel cooperative idea

CHICAGO—Three new departments have been opened by the Illinois Radio & Electrical Dealers Association.

"If you are over-stocked on any item or have slow-moving merchandise that you would like to trade for something else, let us list it in our bulletin", secretary J. G. Strader advises members.

Addresses and descriptions of customers who have skipped with merchandise is also listed in the bulletin referred to.

Also, the group now provides legal service for general use by members.



FISHERMAN SIRAGUSA—Ross Siragusa, president of Continental Radio and Television, goes after muskies at Turtle Flowage, Park Falls, Wisconsin

New Rotary Machine Maker

Eicor, Inc., to make dynamotors, converters, gas-electric plants

CHICAGO—Entering the business of manufacturing dynamotors, converters and gas-electric plants is Eicor, Inc., with offices and plant at 515 S. Laffin Street, this city. Joe Nader is president and chief engineer, R. D. Wright vice-president and sales manager. Both have had many years of experience in the field.

Said president Nader, interviewed here: "My engineering studies have uncovered several important features for quieter, smoother designs, which will assure exceptionally long life of all component parts."

RSA Chapter Meeting Dates

CHICAGO—From Joe Marty, Jr., executive secretary of the Radio Servicemen of America, Inc. with headquarters at 304 South Dearborn Street, comes the following tabulation of RSA chapter meeting dates:

Alton, Ill.	First and third Tuesday of each month.
Binghamton, N. Y.	First and third Tuesday.
Boston, Mass.	Every fourth Monday.
Chicago, Ill.	Second and fourth Wednesday.
Cleveland, O.	First Monday, third Wednesday.
Colorado Springs, Colo.	Second and fourth Friday.
Davenport, Ia.	First and third Tuesday.
Decatur, Ill.	Every Tuesday.
Duluth, Minn.	First and third Thursday.
Freeport, Ill.	First Monday, second Tuesday.
Fremont, Ohio.	Second and Fourth Monday.
Green Bay, Wis.	Second and fourth Wednesday.
Holyoke, Mass.	First Tuesday.
Houston, Tex.	Second Wednesday.
Jamestown, N. Y.	First Monday.
Lynn, Mass.	Second and fourth Tuesday.
Newark, N. J.	Oct. 12, 25; Nov. 9, 22; Dec. 6.
New Bedford, Mass.	Third Wednesday.
Southern N. H.	First and third Tuesday.
New York, N. Y.	Second and fourth Monday.
Ogden, Utah.	Every other Monday.
Oklahoma City, Okla.	Every Tuesday.
Pontiac, Mich.	Second and fourth Monday.
Quincy, Ill.	Second Monday.
Stuebenville, O.	First and third Wednesday.
Westchester (N. Y.)	Second and fourth Wednesday.

\$14,999,486.72 For A Dog

Five tube dealers come close with \$15,000,000 estimate in Victor contest, receive \$1000 each. Many additional prizes

CAMDEN—\$14,999,486.72. . . This is the exact sum spent in the last ten years to popularize the Victor Dog Trademark and its slogan: "His Master's Voice," according to an audit. Judges O. Fred. Rost, Editor of *Radio Retailing*; Glad Henderson, O. H. Caldwell, S. Knellar and R. D. Washburne found among submitted estimates by competing RCA Victor tube dealers five for \$15,000,000, awarded each one of the following a \$1,000 first prize promised in the event of a tie:

- E. L. Cane, Shenandoah, Virginia.
- Hoffman's Radio Service, Edgewood, Ill.
- Alphonse F. Pelovsky, Le Center, Minn.
- John H. Schwarzkopf, Chicago, Ill.
- West Kentucky Coal Co., Sturgis, Ky.

To these fifteen contestants went \$100 each in RCA Victor merchandise: Alco Radio, Brooklyn; P. L. Barth Co., Cincinnati; F. H. Burchfield, Warrensburg, Mo.; Horace M. Burke, Wildwood, N. J.; Bernard Eger of Anderson & Co., Ishpeming, Mich.; Emerald Radio Shop, Chicago; S. J. Fass of Whitehouse, San Francisco; Fordham Radio of Jackson Heights, L. I.; Henry A. Fox, Dunlo, Penna.; Ernest Groschr, Lake Arrowhead, Calif.; E. M. Haas of The Radio House, San Francisco; A. G. Herbst, Eureka, Ill.; Kubinsky Radio Electric, Bridgeport, Ohio; A. H. Matusek, Pittsburgh; Radio Central, New York City; Valore Hardware, Littleton, Colo. and Zenith Radio Store of San Pedro, Calif.

Thirty entries received \$50 each in RCA Victor merchandise: Arlington Electric, St. Paul, Minn.; Gilbert Bloom, Oxford, Ind.; Broad Electric, Newark; George E. Burkholder, Napoleon, Ohio; Camacho & Lubera, New Bedford; L. Devito, Jamaica, N. Y.; Di Vito Music, Waterbury; FAMILTON'S, College Point, N. Y.; L. B. Judd, Grandview, Wash.; Kirksville Radio & Electric, Kirksville, Mo.; Koop Radio, Somerville, Mass.; John Kuh, Grindstone, Penna.; Lakeview Radio Service, Oakland; Larchmont Radio Salon, Los Angeles; R. L. Levenson of Reichart's, Wheeling; J. A. Mohr Radio, San Francisco; Nacliman's, Washington;

New England Radio, Malden; Pasco Hardware, Pasco, Wash.; Olneyville Battery, Olneyville, R. I.; Queensboro Radio, Jamaica, N. Y.; Rexall Store, Munday, Tex.; James Ribando, Chicago; D. W. Scribner, Island Pond, Vt.; Superior Radio Service, Grand Rapids; J. G. Vinciguerra, Boston; Fred E. Weale, Pt. Jervis, N. Y.; Carl Weesthrey, Hoopston, Ill.; Zellner Mer Co., Tonganoxie, Kans. and H. Zemel of Radio Centre, New Haven.

Tester Show Successful

RSA Chicago Chapter plans to repeat every year

CHICAGO—The local chapter of the RSA held the most successful meeting in its history September 28, providing free exhibit booths for test equipment manufacturers, holding a round table discussion of tester problems and so attracting 550 servicemen to the event. Parts jobbers in the area cooperated by urging their customers to attend and the affair was so well thought of by all concerned that it was decided to make it an annual event.



BIG DOG NOW—The big pooch, well-known Victor trademark, is wired for sound, plays phonograph records. The small one is inanimate, goes out to dealers for use in displays. RCA Manufacturing Company's president *George K. Throckmorton* looks over the animals preparatory to shipment as part of the concern's Fortieth Anniversary celebration



ANIBAL AND SON—Stromberg-Carlson's distributor manager *Fred N. Anibal* and son *Arthur*, snapped in the Adirondacks at Blue Mountain Lake

Labyrinth Week Plans Ready

Stromberg's McCanne cites factors favorable to successful drive

CHICAGO—Members of Stromberg-Carlson's Chicago and Kansas City divisions gathered here late in September to make final preparations for midwest activity in the second national "Labyrinth Radio Tone Week" to be held October 8-15. Announced were many new sales aids, including a display in which prospects can "see sound disappear", a new neon sign to identify authorized dealers, window streamers inviting the public to "come in and take the Labyrinth proving test" and a revised "How To Choose a Radio" booklet.

Spotlighting factors favorable to a good season and a good Labyrinth Week campaign was radio sales manager Lee McCanne, who made the following points: "Radio business is good in an election year . . . Conditions in Europe and Asia keeps people on edge following news reports . . . Little sets purchased during the depression are being replaced with bigger sets . . . We are fast moving into an era of multiple-radio homes . . . Government economists are reporting general business coming back fast."



RCA'S DISTRICT EXECS—At Camden headquarters to hear plans for the firm's Fall merchandising and sales promotion drive; *James W. Cocks*, *William H. Kelley*, *S. D. Camper*, *Richard Graver*, *George Ewald*, *John K. West*, *M. F. Blakeslee*, *E. J. Rising*, *Dale Neiswander*, *Joseph B. Elliott*. Standing, *Fred D. Wilson*, headquarters man in charge of district sales

Bendix Testers Announced

DETROIT—Announced by the Bendix Radio Corporation, sales offices at 8-204 General Motors Building, is a line of Bendix precision-engineered automotive electrical and radio test equipment. Details are to be made available to the trade shortly.

Why voters today — as their

IN THE OLD DAYS, the grandfather of today's voter got his political facts from the rumor experts around the cracker barrel in the village store. Authoritative, non-partisan sources of information were hard to find. Never could grandfather push a button and tune in a radio discussion of both sides of a political issue . . . local or national. Probably grandfather never heard a President speak. He never listened to an English King or a French Minister. Foreign issues and even most national issues were a closed book to many before the days of radio.

What the American System of Radio has done for Voters today

Today every man in the radio business from engineer to dealer can take a bow for his share in performing a real public service for all America. Now the Nebraska farmer and the old lady in California have the opportunity to be as close to national and international affairs as the alert resident of Washington. By reporting events impartially as they happen . . . by presenting both sides of every national or local issue . . . radio helps improve the nation.

RADIO BRINGS OUT THE VOTES . . . BY BRINGING OUT THE FACTS

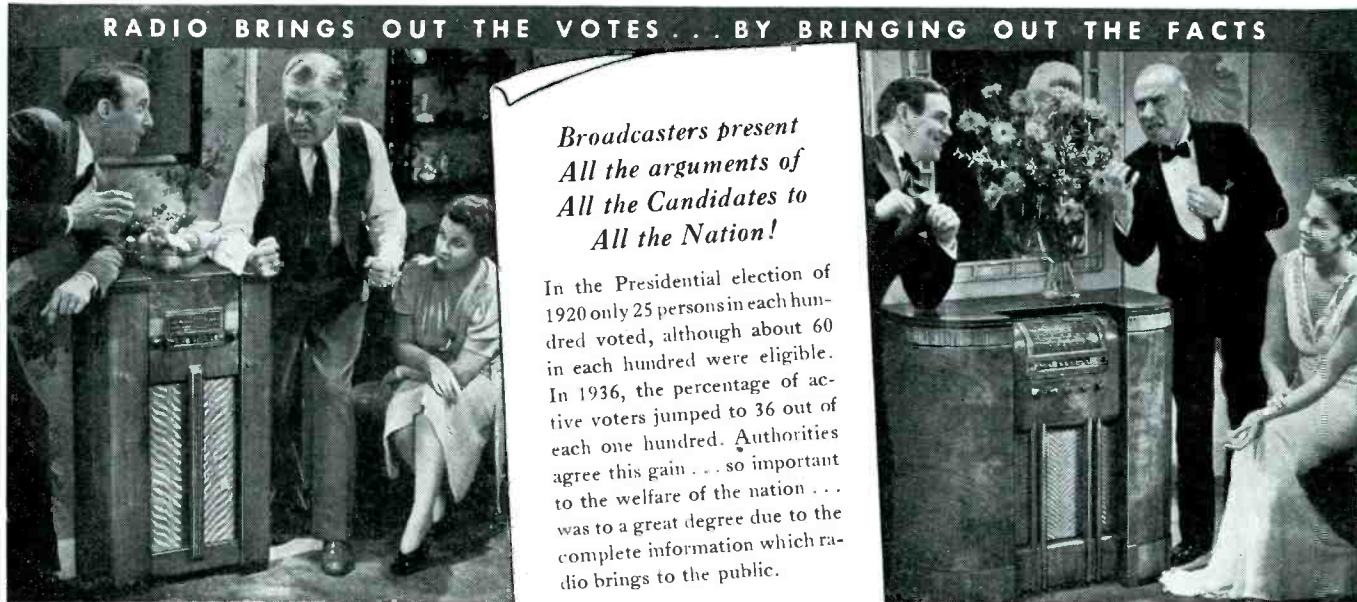

*Broadcasters present
All the arguments of
All the Candidates to
All the Nation!*

In the Presidential election of 1920 only 25 persons in each hundred voted, although about 60 in each hundred were eligible. In 1936, the percentage of active voters jumped to 36 out of each one hundred. Authorities agree this gain . . . so important to the welfare of the nation . . . was to a great degree due to the complete information which radio brings to the public.



RADIO CORPORATION OF RADIO CITY

RCA MANUFACTURING CO., INC. • RADIOMARINE CORPORATION OF AMERICA
NATIONAL BROADCASTING COMPANY

know twice as much grandfathers!

An Informed Electorate Makes for a Better America!

Thanks to radio, the American democracy has the opportunity to function better than ever before in history. Radio keeps voters informed . . . on their toes. And greatest of all . . . it gives them the opportunity to form intelligent opinions based on unbiased facts. The National Broadcasting Company, one member of the great radio family of RCA, has always performed an outstanding service in this respect. Last year there were 821 microphone appearances of prominent statesmen over NBC Networks. This year, the facilities of all 154 NBC Stations are again available to leading candidates.

By Radio Merchants Developing Radio on a basis of public service . . . RCA Develops Opportunities for Dealers

Since its inception, the Radio Corporation of America has played a most important part in originating and developing new services in radio. Much that makes radio the most vital and interesting force in American life today is "RCA All the Way." The public recognizes RCA's contributions . . . the public realizes the benefits they receive by going "RCA All the Way." As a result, year in and year out, there is a rich field of opportunity for RCA Victor merchants.

*RCA presents the Magic Key every Sunday, 2 to 3
P.M., E.S.T., on the NBC Blue Network.*

AMERICA

NEW YORK

RCA COMMUNICATIONS, INC.
RCA INSTITUTES, INC.

RADIO RETAILING, OCTOBER, 1938

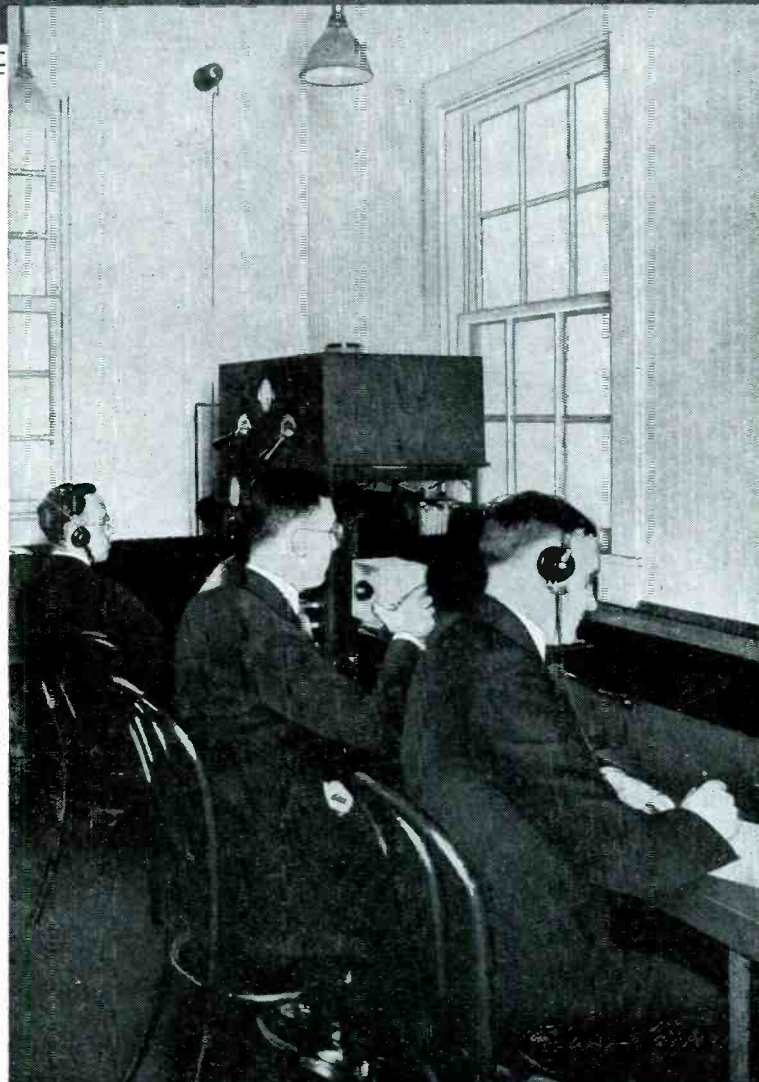

**WORLD'S FIRST POLITICAL BROADCAST
NOVEMBER 2, 1920**

This photo shows scene during world's first pre-scheduled radio broadcast, when station KDKA in Pittsburgh sent out Harding Presidential election returns in

1920. Second from right is the announcer in front of microphone which resembles primitive telephone transmitter. KDKA is now an outstanding NBC station.

Kadette Goes Direct

1939 line sold under Fair Trades Agreements drops jobber

ANN ARBOR—With the introduction of its advanced, new 1939 line of Kadette radio receivers and accessories, International Radio Corporation has inaugurated an exclusive direct-to-dealer sales policy operated under Fair Trades Agreements.

According to president C. A. Verschoor, the new line will be a radical departure from conventional design and will neither look like nor compete with anything else in radio. Stated Mr. Verschoor: "With the conventional type of radio line, the jobber is indispensable and, in our opinion, always will be."

Leader of the new Kadette line just announced is its Autime "electric clock" receiver which has the appearance and performs the exact time-keeping functions of an electric clock while serving at the same time as a radio receiver which may be pre-set to turn on automatically any radio program selected.



KADETTE'S SALES STAFF—Convening September 30-October 1 to witness unveiling of the International Radio Corporation's new "Tunemaster": Seated: *Al Rapfogel, H. C. Guterman, George Bruder, Lynn Stewart.* Standing: *W. Keene Jackson, J. F. McCollum, Al Saphin, Jack L. Hursch.* Samples of the new set already have gone to dealers

Clough-Brengle Plan Gaining Ground

CHICAGO — From Kendall Clough, president and chief engineer of the Clough-Brengle Company, comes word that adoption of a universal standard of final test procedure for radio service shops affiliated with the Radio Servicemen of America, as advocated by the Chicago chapter's Lewis P. Evans, chairman of the Shop Standards and Practice Committee, would parallel recommendations in the C-B book "Complete Dynamic Testing."

Members of the RSA's Chicago

Chapter, according to Clough, are being invited to contribute ideas as to points to be covered and standards to be established for the final test program, for consideration by the entire Chicago membership at an early date.

Magnavox Ups Koonz

FORT WAYNE—J. C. Koonz has been named sales manager of The Magnavox Company's Capacitor Division. He joined the firm in 1928 and has worked in the

Chicago, New York and Philadelphia territories as salesman and district manager.

Daco Testers Near Production

CINCINNATI—From David E. Johnson, recently appointed sales manager of the Dayton Acme Company, comes word that a complete new line of radio testing equipment bearing the trademark "Daco" is virtually ready for production. Dayton Acme, maker of special test equipment for the past eight years, continues to render modernization and routine service on "Dayrad" test instruments.

Deeley's Book Moving Well

SOUTH PLAINFIELD, N. J.—Moving well at \$3 among radio engineers, amateurs, technicians and servicemen is Paul McKnight Deeley's new 275-page cloth-bound book "Electrolytic Capacitors". Covering as it does the theory, construction, characteristics and application of all types, the book is the first of its kind concentrated upon just one component and dealing with it as only the chief engineer of a leading manufacturer in the field could cover the subject. Paul McKnight Deeley heads Cornell-Dubilier Electric Corporation's electrolytic division and his book is obtainable only from this source.

30 Years Of Clips

CLEVELAND—Mueller Electric celebrated its 30th anniversary in the clip business September 1. The company held open house for the many friends of founder Ralph S. Mueller and other members of the firm.



BEAMSCOPE CONQUERS SUBWAY—To New York's noisiest locations late in September went General Electric field engineers testing a receiver with a built-in antenna designed to pick up signals electromagnetically, shut out manmade static through the use of electrostatic shielding. Sets played in the Empire State tower, in the building's sub-basement, in subway stations (see photo).

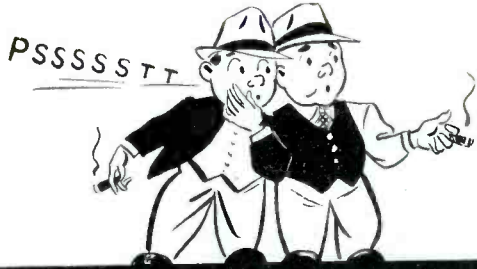

THERE'S MORE
SWITCHING TO
STANCOR
TODAY
THAN TO
ANY OTHER LINE
IN THE
TRANSFORMER
FIELD . . .

*There must
be a Reason!*

STANCOR

STANDARD TRANSFORMER
CORPORATION

1500 NORTH HALSTED ST. • CHICAGO



HOT NEWS!
This Modern Equipment
is **EXTRA PROFIT**
for You!



NEW SALES HELPS!

● **FREE . . .** your copy of the **ARCTURUS DEALER HELPS** folder—showing the finest line-up of sales-builders on the market today! . . . most items absolutely **FREE**.



RADIO'S FINEST TUBES!

. . . and now the **ARCTURUS "GT" MIDGETS!** May be used to replace metal tubes. Thousands now being used in the new "Midget" sets are creating a huge replacement market. Cash in on it! . . . "Go Arcturus!"

The IMPROVED
**ARCTURUS
EQUIPMENT DEAL**

Better, more complete than ever—with a new assortment of the very latest models of test and service equipment — that's the **Improved ARCTURUS EQUIPMENT DEAL!**

In addition to this wider selection of equipment, you now have your choice of Neon Signs, Cash Registers, Typewriters and Electric Clocks—new items that make your sales and office work easier, more efficient! . . . at almost **NO COST** to you!

The **ARCTURUS EQUIPMENT DEAL** actually gives you a "**TWO-WAY**" profit—your regular profit on every tube you sell . . . **PLUS** substantial cash savings on the equipment you need!

PREPARE NOW FOR BETTER BUSINESS

And remember: the **ARCTURUS DEAL** is still the most liberal ever offered — Lower Down Payments . . . Low Tube Requirements . . . Tubes at Standard Prices . . . Immediate Delivery of the equipment you select!

Prepare **NOW** for the busy months ahead. Let your regular purchases of **ARCTURUS TUBES** give you the "best equipped shop in town"! Get the facts!

MAIL THE COUPON!

ARCTURUS

ARCTURUS RADIO TUBE CO., Newark, N. J.

Without cost or obligation, send my copy of the **ARCTURUS DEALER HELPS** Folder and details of your new equipment deal.

Name.....

Street.....

City.....State.....

I am a dealer I am a serviceman. My jobber is.....

For your convenience this coupon can be pasted on a penny postcard

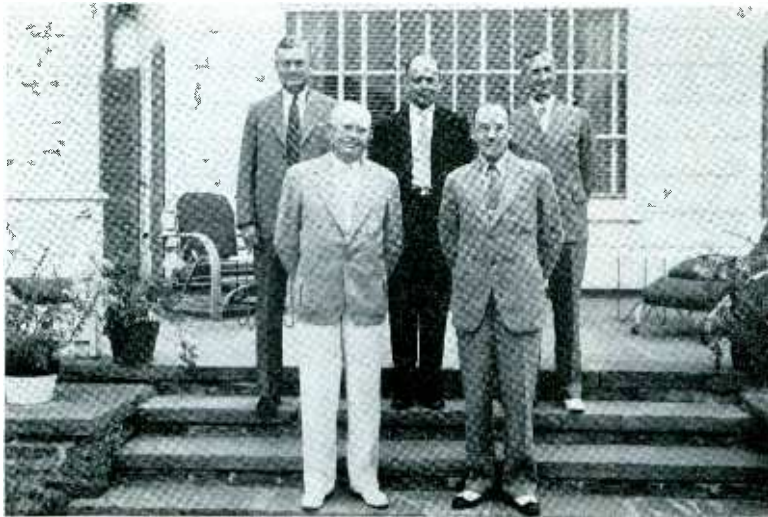

HYGRADE MEN—Snapped at Hygrade-Sylvania president Erskine's home near Emporium, left to right: Vice-president *W. E. Poor*, treasurer *F. A. Poor*, secretary *J. S. Leuroyd*, from Salem . . . Host *B. G. Erskine* and vice-president *M. F. Balcom* of Emporium

French Give Medals

CHICAGO—From McMurdo Silver, president and chief engineer of the radio corporation that bears his name, comes word that his receivers won the Grand Prix in the 1937 Paris Exposition, just awarded. Diplomas of honor went to E. H. Scott and RCA Victor. Gold medals were sent Crosley and Capelhart.

Significant feature of the awards was the complete absence of European sets from the high honors list, despite the fact that only one American was a member of the International Award Jury.

Crosley Name Change

CINCINNATI—Stockholders of the Crosley Radio Corporation have ratified a proposal to change the corporation's name to the Crosley Corporation. Reason given for change: Old name covered just one of the concern's many important activities.



MILLION, VON JENEF—*John W. Million, Jr.* (left), president of the Million Radio and Television Labs., chats with his new chief engineer, *H. D. Von Jenef*, formerly with Wells-Gardner, Continental Radio, Littelfuse, Montgomery-Ward and more recently consultant for the Televiso Company

Engineers Meet Nov. 14-16

ROCHESTER—The Institute of Radio Engineers and the RMA's engineering department hold a joint meeting at the Sagamore Hotel November 14-16. Many technical papers are planned as are also exhibits of parts, tubes and accessories.

Two Norge Appointments

DETROIT—P. B. Zimmerman, vice-president in charge of sales for the Norge Division of the Borg-Warner Corporation, announces two appointments to the Norge sales staff. Glenn O'Harra, former sales manager of the range division, becomes eastern sales manager. R. E. Densmore, former refrigeration sales manager, becomes western sales manager for Norge.



GENIAL GUIDE — *Harry Savage* (right) of Oklahoma City's Southern Sales visited IRC in Philadelphia. Factory sales manager *Dan Fairbanks* showed him the sights, had this picture snapped at Washington's Valley Forge headquarters

ARA Show Postponed

CHICAGO—The convention of the American Radio Association, scheduled to take place here in the LaSalle Hotel September 30-October 2, was postponed. According to secretary Marcus W. Hinson it was felt that the relatively short notice given manufacturers that the convention would permit exhibits of equipment prevented many from arranging for displays in time. Holding of the convention at some later date will, stated Hinson, permit more manufacturers to tie in.

Triplett Competition

BLUFFTON, OHIO—Under way at the present time and running until November 15 is a competition for servicemen by The Triplett Electrical Instrument Company. Offering its own instruments as awards, the company invites letters describing puzzling service problems and the way in which intelligent use of test instruments provided a solution.

Entries must be made on blanks available at all Triplett instrument distribution points.

New Westinghouse Refrig Sales Head

MANSFIELD—H. M. Butzloff has been appointed sales manager of the Westinghouse Electric & Manufacturing Company's household refrigeration department, moving here from the northwestern district offices in Chicago.

Shapiro Wins Prize

NEWBURGH, N. Y.—From J. Weisman of the Shapiro Sporting Goods Company comes word that this firm has just been named a winner in RCA's Victor Radio contest for distributors. Shapiro will celebrate at a mammoth birthday party celebrating the 40th anniversary of the RCA Victor trademark.



ICE TO THE ESKIMOS—you can't keep a born salesman down. *Harold Sugar* (left), v.p. and g.m. of Baltimore and Washington's Sun Radio took time out recently to give a sales talk about Motorola's time-tuning to *James H. Simon* of Simon Distributing . . . who wholesale's the sets!

With THIRTY-FIVE MILLION "BUY-NOW" MESSAGES

Emerson

LAUNCHES ITS GREATEST ADVERTISING PROGRAM



In "top-flight" National Magazines — in leading local newspapers — reaching more than THIRTY-FIVE MILLION circulation—backed by powerful point-of-sale displays and general publicity—EMERSON is launching the greatest and most intensive sales promotion campaign in the company's history.

Beginning with a large ad in the November issue of *ESQUIRE* (out October 14) — followed by a full page, full-color ad in the October 23rd issue of *THE AMERICAN WEEKLY* — and following through with *THE SATURDAY EVENING POST*, *COLLIER'S*, *LIFE*—here is a campaign for the "World's Biggest Selling Little Radio" that will bring thousands of ready-to-buy customers into Emerson dealers' stores.

Ask Your
EMERSON Distributor
for Details

Emerson's campaign has a lot of "PLUS" features that mean EXTRA business for YOU. Your Emerson distributor is equipped with all of the facts and materials to help you capitalize this promotion. Get in touch with him NOW.



More than 15,000,000 circulation in National Magazines.

More than 20,000,000 in Local Newspapers.

EMERSON RADIO AND PHONOGRAPH CORPORATION
World's Largest Maker of Small Radios • *New York, N. Y.*

AGAIN in '39 Admiral

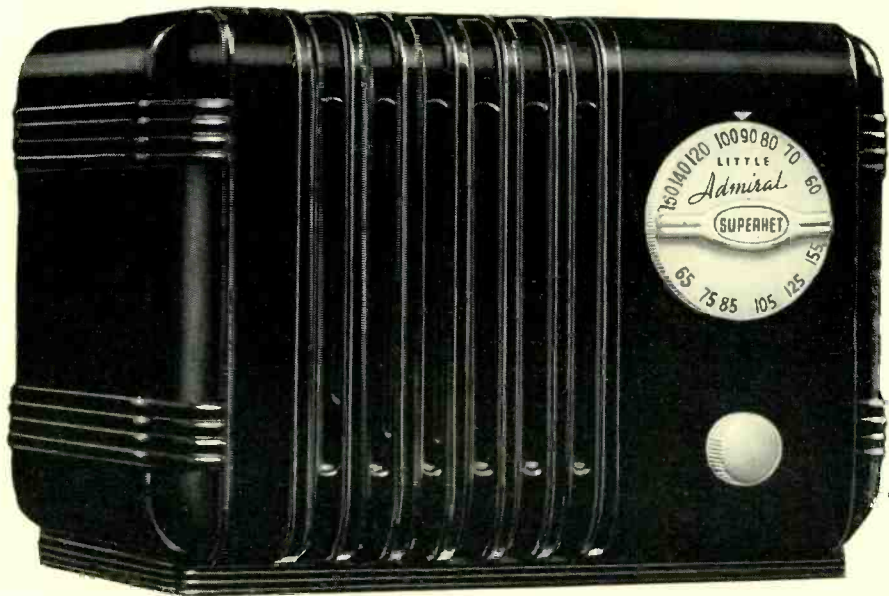

... IN PRICE ...

\$ 9.95

Standard
MODEL
123-5E
BLACK

Deluxe Models
Model 124-5E—walnut
Model 125-5E—Ivory
Model 126-5E—Red

Also Competitively Priced

ADMIRAL RADIO - PHONOGRAPH ONLY \$69.95 LIST



Left—Model 549-6G. Admiral does it again! A radio-phonograph console at a price usually charged for table models! 6 tube AC superhet radio has 8 push-button permeability tuning. Covers two bands. Has slide rule dial . . . 8" electro dynamic speaker . . . automatic push-button wave band switch. Phonograph has new lightweight crystal pick-up floating in rubber with self-starting electric motor and automatic stop. Plays up to 12" records. Smartly styled cabinet with wrap around pilasters of sliced walnut and top of striped walnut measures 25" wide, 33" high, 14" deep.

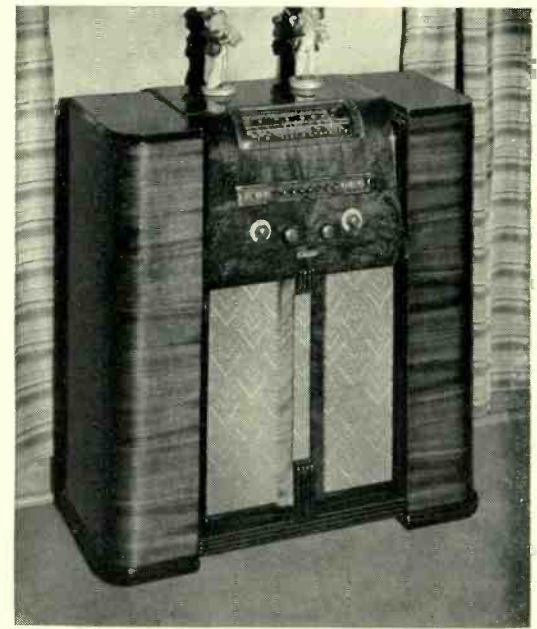

Right—Model 139-11A. A.C. Superhet Console Grand with tilt-tuning dial . . . electric automatic tuning . . . gold calibrated slide rule dial . . . push button off-on switch . . . push button operated tone control plus manual base compensation to give 42 tone variations. Has 10 watts output . . . full A.V.C. . . . AFC . . . pre-selector . . . 12" electro dynamic speaker . . . 3 bands. Tunes American broadcast and foreign stations, police, amateur, aviation, ships-at-sea.

BATTERY RADIO

With Sensational New 1½ Volt Tubes Model 141-4A, 4-tube Superhet Table Radio operates for almost a year from one "AB" battery. Single plug-in connection does away with messy wires. New superhet circuit gives 5-tube performance. Tuning range 535 to 1735 KC. Tunes American broadcast and police stations. Has slide rule dial . . . full A.V.C. . . . 6" P.M. dynamic speaker.

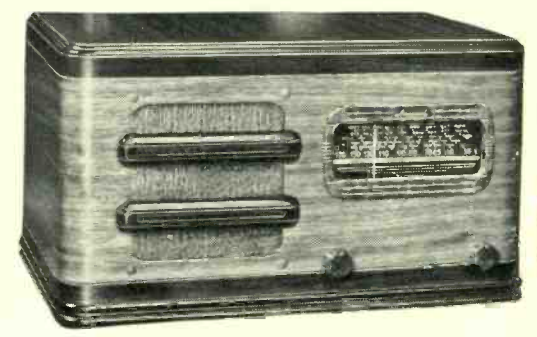

36 Models to Choose From!
4 to 16 Tubes—See Your
Jobber or Write Us

CONTINENTAL RADIO & TELEVISION CORP., 3800 W. CORTLAND ST., CHICAGO

RULES THE AIR-WAVES!

PERFORMANCE... DESIGN

Meet "Price Competition" with the *Little Admiral*
A Full 5-Tube AC-DC Super as Low as \$9.95

You can depend on Admiral to keep one step ahead of the parade . . . in price . . . performance . . . design. Here's a new 5-tube super that will help you get your share of the midget radio business. Has 5 working RCA metal tubes in improved superhet circuit to give 7 tube performance . . . automatic volume control . . . pilot light . . . range 535 to 1735 KC. Modern one-piece molded plastic cabinet available in four attractive colors.



NEW 1939 ADMIRAL RADIO-PHONOGRAPH



Above Model—142-8A Radio-Phonograph Console. 8-tube AC superhet radio with permeability push button tuning. Has large, easy-to-read slide rule dial . . . continuously variable tone control . . . full A.V.C. . . . extra heavy electro dynamic speaker. Three bands. Tunes American broadcast and foreign stations, police, amateur, aviation and ships-at-sea. Phonograph includes automatic record changer which plays 10" or 12" records automatically in mixed sequence. Has top loading crystal pickup with automatic needle cup and triple sealed crystal cartridge.

WIRELESS RECORD PLAYER

With Microphone Attachment

Can be used as a P. A. System . . . Also lots of fun "broadcasting" at home.

Model AW 11. Wireless Record Player—Completely portable. No wires from player to radio. Plays up to 12 inch records. Has self-starting motor . . . automatic stop . . . needle cup . . . arm rest . . . off-and-on pilot light (signals when record player is in operation) . . . 2-position power control switch. Lid closes on 12 inch records. Smartly styled cabinet of figured walnut with piano finish measures 13 inches by 13 inches by 6½ inches. Sensationally low price.



Left—Model 521-5C 5 tube (including ballast) T.R.F. Radio-Phonograph with 5" electro dynamic speaker . . . 2 watts output . . . one stage R.F. tuning range 535 to 1735 KC. Tunes American broadcast and police stations. Phonograph has new light weight crystal pickup and 78 R.P.M. quiet electric motor. Plays up to 12" records with top closed.

Model 521-5F A.C. Superhet Table Radio-Phonograph. 5-tube 110 volt radio with tuning range 535 to 1735 KC. Has 5" electro dynamic speaker. Phonograph and cabinet same as Model 521-5C. Underwriters approved.

AMAZING.. STARTLING

WIRELESS CONTROL FOR ANY RADIO

WITH KADETTE *Tunemaster*

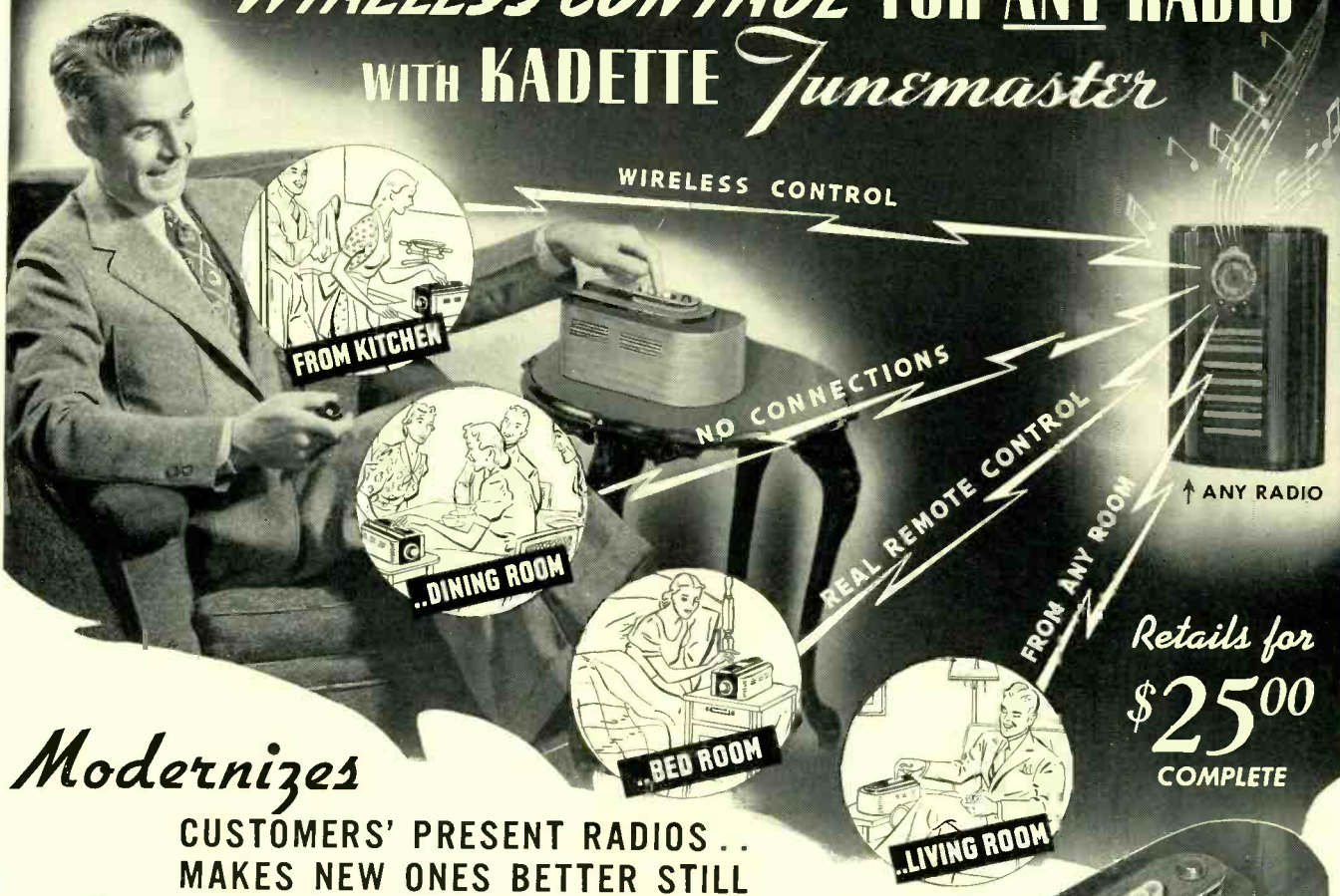

Retails for
\$25⁰⁰
COMPLETE

Modernizes

CUSTOMERS' PRESENT RADIOS...
MAKES NEW ONES BETTER STILL

Over 20,000,000 Prospects!

TO visualize the tremendous sales possibilities of Kadette Tunemaster, just imagine yourself lounging at ease the whole evening through, really enjoying radio as you have never enjoyed it before. Never once is the spell broken by having to leave your chair to change programs or adjust volume. Think, too, how convenient for the busy housewife. She can carry *Tunemaster* from room to room and operate a radio anywhere else in the home as easily as if sitting beside it.

But this is only the beginning of the alluring sales-compelling picture. *Tunemaster* actually improves reception—sharpens tuning—increases sensitivity—gets distant stations with greater volume. In addition, it provides push-button tuning for four stations, remote volume control and true wireless tuning—not for just a few stations—but for every station on the broadcast band from 540 to 1500 Kilocycles! Yet, the radio can still be used as before. Nothing is added to it—nothing taken away. Merely

plugging *Tunemaster* into any electric outlet (AC or DC) is the only installation!

You don't merely tell this exciting story—you PROVE it! *Tunemaster* itself backs up every word. There's something you can REALLY sell, and virtually every radio owner is an immediate prospect. You will find, too, that a surprisingly high percentage who come to buy *Tunemaster* will easily be persuaded to replace antiquated radios with new ones, and those who come to buy a new radio will be just as easily persuaded to add *Tunemaster*.

What's more, there will be no lack of opportunities for such sales. Powerful national advertising that starts with a full page in the November 5 issue of *SATURDAY EVENING POST* will soon have millions looking for *Tunemaster*. Someone in your community is going to grab this unparalleled opportunity, and it might as well be YOU. Mail the coupon on the right for full details. INTERNATIONAL RADIO CORPORATION, Dept. P-60, Ann Arbor, Mich.



Mail COUPON NOW

INTERNATIONAL
RADIO CORPORATION
Dept. P-60, Ann Arbor, Michigan
Rush full information about KADETTE
TUNEMASTER and your new LIMITED
DEALER-FRANCHISE plan.

Firm Name

By

Address

City..... State

KADETTE RADIO INTERNATIONAL
RADIO CORP.
ANN ARBOR, MICH.

Dealer Helps

HOW TO SELL ANTENNAS—

Available from the *Belden Manufacturing Company* of 4647 W. Van Buren St., Chicago, is a new 16-page booklet entitled "How to Sell Better Antenna Installations." Starts out with reasons which will convince the average consumer of the importance of equipping his set with an efficient skywire, continues with methods of promotion useful to both dealers and servicemen, winds up with reasons why an antenna campaign helps sale of sets themselves, service and additional accessories. Gives details on complete Belden Clear Channel Antenna Systems.

RECORD CABINETS—

Schloss Brothers of 801 East 135th St., New York, offers a new folder describing the picturing and pricing its line of cabinets designed to house phonograph records and masterpiece record albums.

PICKUPS—Literature giving detailed specifications of the new Audax line of Microdyne pickups, relayed-frequency type as well as the new compensated Microdyne type, is ready. Made up in the form of sheets suitable for catalogue insertion. Write the Audak Company, 500 Fifth Ave., New York, Department E.

DWARF, ET.AL.—An attractive four-color broadside was released to the trade late in September by *Halsion Radio & Television, Inc.* Describes the entire 1939 Halsion line including its little "Dwarf" model, latest addition.

HOWARD—*Dunham, Carrigan and Hayden* of San Francisco get the Howard household radio line. Despite the trucking strike in California, dealers are assured of delivery as the factory managed to get three carloads through before it broke. State of Washington distribution goes to *Seattle Radio Supply*. *Glasgow-Stewart* of Charlotte, N. C. handles its own state and South Carolina. *Freck Radio and Supply* of Asheville and Highpoint and *Clinard Electric* of *Winston-Salem* continue in their respective territories. Exclusive distribution of the Howard household receivers in North Central Iowa go to *Standard Battery and Electric* of Waterloo.

ANTENNA WEEK—*Stromberg-Carlson* has put out a special window display card designed to actually show one of its antenna kits to tie in with the October 15-22 "National Antenna Check Up Week."

TRANSFORMER COMPONENTS

—Complete, illustrated data on the entire *United Transformer Corporation* line is given in a newly-released 15-page booklet bearing this title. Mechanical sizes, impedances, voltage and current ratings and everything else an experimenter, amateur or repairman is apt to ask about the line is here. Write 72 Spring Street, New York, mentioning this item in *Radio Retailing*.



CELEBRATING—Celebrating the arrival in Chicago of the year's biggest salmon from the Pacific Northwest were these prominent radio industry execs, guests of V. Hamilton

CONDENSER PREDICTER—Do you know when to replace condensers without waiting for them to fail completely? An eight-page booklet prepared by *John Meck Instruments*, 164 N. May Street, Chicago, answers this and other servicing questions. Free, if the request goes forward on your business letterhead.

CONDENSERS—The complete *Cornell-Dubilier* line of capacitors, with electrical and mechanical characteristics, is described in a 40-page catalog. Ask for No. 161. No charge. 1270 Sixth Ave., New York City.

SPEAKER PARTS—*Leotone Radio Company* of 63 Dey St., New York, has a new 36 page booklet listing its line of replacement speaker cones and field coils and speaker replacement parts. Lists hard-to-get equipment, with list prices. Confidential discount sheets come separately. Mention *Radio Retailing*, use your business stationery.



KING FOOTBALL—Effective promotion as the football season gets under way is *Stewart-Warner's* presentation of "Varsity" radios to famous players, publicizing of the gifts. Here's *Byron "Whizzer" White*, All-American from Colorado, one of the many recipients

SALES MANUAL—*National Union* has just provided its distributors and distributor salesmen with a 102-page sales manual for the 1938-39 selling season. Spiral wire bound, containing complete descriptions of test instruments available as part of tube deals. Pages are also devoted to N.U. equipment such as condensers, photo-cells, exciter lamps, panel lamps, shop coats, carrying cases.

MAPS—Two azimuthal world projection maps prepared by the radio department by *General Electric* are available free to amateurs, from Schenectady. One is centered on Schenectady and is for use in the northeastern United States. The other is for amateurs in the western part of the country and is centered at Oakland. Principle cities of the world are indicated as are their distances and exact direction.

WIRE—Catalog 38 is available from the *Alpha Wire Corporation* of 50 Howard St., New York. Completely describes the company's wires, antenna accessories and complete kits, clips, plugs and other products.

SOUND—*David Bogen Company, Inc.* of 663 Broadway, New York, has just released a new 20-page catalogue No. P9-38A describing the complete 1939 line of Bogen sound systems.

SOUND DATA—*Transformer Corp. of America*, through the Clarion Institute of Sound Engineers, announces a new complete Fall 1939 catalogue covering its sound systems and accessories. Includes new amplifiers, complete systems, microphones, speakers, baffles and many other items, giving list prices.

SPEAKERS—*Jensen Manufacturing Company* of 6601 S. Laramie Ave., Chicago, has a 16-page speaker catalog just off the presses. Covers the greatest variety of sizes, types and models ever offered by the company.

SET PICTURES—All there is to know about the new line of the *Garod Radio Corporation*, 115 Fourth Ave., New York, is inclosed between the covers of a multi-page picture illustrated book by this firm.

INVENTORY CONTROL—This is the title of a leaflet by the *Hytron Corporation* of 76 Lafayette St., Salem, Mass. Groups tubes in such a way that the maximum of stock coverage with the minimum of investment is possible. Mention *Radio Retailing* and get your copy without charge.

SOUND SALES HELP—*Webster-Chicago* of 5622 Bloomingdale Ave., Chicago, has a new four-page mailing piece entitled "The Greatest Selling Opportunity in Sound History." Free on request, pointing out highspots of concern's line.

MIKES—*Universal Microphone* of Inglewood, Calif., late in September issued a series of loose-leaf sheets, illustrated, depicting its microphone line and condensed from the early summer catalog.

SOUND BULLETINS—Number 2, Volume 4 edition of the *Sound Apparatus Company's* Sound Apparatus Bulletin is off the presses. Describes a Simplex recording mechanism, Saja motors for turntables. Address: 150 West 46 St., N.Y.C.

DIE-CUT DISPLAYS—*Triad Manufacturing* of Pawtucket, R. I., now has three die-cut displays ready for distribution. Suitable for window and floor use. Four colors. Included with orders shipped from the factory or from jobbers.

N-U Doubles Ante

NEW YORK—To William J. Bauer of the Bauer Radio & Appliance Company, St. Louis, the winning of second Class A prize in *Radio Retailing's* "Tube Sales Idea Contest" (all winners reported elsewhere in this issue) unexpectedly brought double monetary reward. Bauer's entry drew a \$25 check from the magazine. In addition, he has just been informed by S. W. Muldowney, president of the National Union Radio Corporation, that because he handles "National Union" tubes this company takes pleasure in adding its own check for another \$25.

Weston Competition Closes

NEWARK—First prize in the Weston "50th Anniversary Contest," consisting of a complete serviceman's radio bench equipped with analyzer, tube-checker, oscillator and other equipment, has been awarded to Alfred Kilian, radio serviceman of Chicago. Awards in the contest were based on the most practical and interesting answers to the question: "How modern test equipment helped me to solve a difficult servicing problem."

Second prize, a combination high-sensitivity analyzer and tube-checker unit, was awarded to Francis Troiani, Jamaica, L. I. Third went to Harl O. Piety, Lampasas, Texas, who received a Weston Model 776 oscillator. Other prize-winners were, in order: Herbert Bussewitz, Chicago; Dependable Radio Service, Great Falls, Mont.; Harvey H. Schock, Reading, Penna.; Floyd A. Martin, Columbus, Ohio; O. R. Sullivan, Jasper, Ala.; Homer C. Buck, Detroit; H. E. Gille, Jersey City; D. Wilkerson, Little Rock; L. B. Hoffman, Palmerton, Penna.; Albert Saunders, Medford, Mass.; Robert Lader, Rego Park, L. I.; L. E. Schaub, Visalia, Calif.; Murray Mayerson, Long Island City; Fred L. Hopfner, Hooper, Nebr.; Thomas A. Herrman, Milwaukee; William B. Coon, Portland, Ore.; Edward McCallum, Philadelphia; Francis M. Johnson, Bloomfield, N. J.; Otis Wrench, Wichita; Harry Carlson, Kokomo; H. E. Wallace, Burlington, N. C. and Carroll Smith, Freeport, Minn.

Judges of the contest were: Leon I. Adelman of Cornell-Dubilier, Robert G. Herzog and H. L. Olesen, Weston's general sales manager.

JOBBERS and REPRESENTATIVES in the News

ADMIRAL—New Continental Radio and Television distributors: *Marshall Wells Company* of Portland and Seattle, *Birmingham (Ala.) Electric, Gambill Distributing* of Nashville, *H. E. Sovenson Company* of Des Moines, *Electric Supply Company* of Oakland, *The Bauman Company* of Minneapolis, *Reid Motor Supply* of Quincy, Illinois, *Stallman* of Ithaca, *Southern Bearings & Parts Company* of Charlotte, *Harbison & Gathright* of Louisville, *Atlantic Electric* of Chicago, *Felt Radio* of Salt Lake, *Hinsdill Electric* of Troy, *Philadelphia Light Supply, Radio Television Company* of Phoenix.

ADMIRAL—Last minute news flash from the factory tells us that the *Sanford Samuel Corporation* gets the Admiral line from Continental Radio and Television for distribution in the New York City area. J. E. Blackburn, Jr. is the exec behind the guns.

MOTOROLA—Galvin Manufacturing announces these newcomers to the Motorola fold: *Kierulff & Company* of Los Angeles has home sets only, *Mills-Morris* of Memphis has both car and home sets, *Strauss-Frank* of San Antonio. *City Service Oil* of Bristol (Va.-Tenn.) has been reappointed western Virginia and eastern Tennessee distributor and will also take over Knoxville.

STROMBERG-CARLSON—*Baldwin-Hall Company* of Syracuse will work the territory adjacent to this city. Fred S. Baldwin is president, H. B. King in charge of radio sales. *Charleston Electrical Supply* is newly appointed for the West Virginia area.

BRUNSWICK—*Sidney Vorzimer*, with headquarters at 206 Lexington, takes over the job of sales representative for this firm in the New York area.

APEX—*Jones Philco Company* of Saginaw now has this washer, ironer, cleaner and refrigerator line, serving northern Michigan. J. E. Jones is president and general manager.

SENTINEL—George W. Russell, sales manager of Sentinel Radio Corporation, has announced the appointment of two new distributors for the company's a.c. and battery radio line. In Little Rock, Ark., the *Fones Brothers Hardware Co.* will have it and in Meridian, Miss., it goes to the *Milton-Brooks Co., Inc.*

ATLAS—Messrs. *Murphy and Cota* are new Atlas Sound sales representatives for Georgia, Tennessee, North and South Carolina. Headquarters at 291 Peachtree, N. E. Atlanta. *J. E. McKinley* of 1819 Ridge Ave., Corapolis, Penna., is to assist *John O. Olsen* of Pittsburgh, traveling West Virginia and a section of western Pennsylvania.

MEISSNER—*The Foster Company* of Minneapolis has this firm's jobbing line in North Dakota, South Dakota, Minnesota, Nebraska, western Wisconsin, northern and western Iowa. Chicago and northern Illinois territory, including eastern Wisconsin and southeastern Iowa, goes to the *Instrument Sales Company* of Chicago. *Ernest B. Scott*, working out of Cleveland, will represent Meissner in Indiana and Kentucky. Colorado, Wyoming and New Mexico goes to *Mountain States Sales Company* of Denver. New England states are to be covered by the *Ralph H. Clawson Company* of Boston.

DETROLA—*Waken & Whipple, Inc.* of Chicago, has just taken on this concern's radio and refrigerator lines. Covering northern and central Illinois and western Indiana, this firm is headed up by general manager Henry Smith.



WESTON WINNER—*Alfred Kilian* of Chicago wins first prize in Weston's "50th Anniversary Contest." Left to right: *Joe Marty, Jr.* and *Ray L. Mason* of RSA, the lucky contestant, Weston's Chicago district manager *Paul A. Westberg* and *W. C. Braun* of Radolek.

**STOP!
LOOK!**



And Read the News About
**RCA'S SENSATIONAL
NEW TUBE TESTER!**



COSTS ONLY
\$37.95

Again, RCA comes through with a winner! This time, it's the sensational new tube tester—that not only offers you more stand-out features than any other—but which costs only \$37.95 net.

Look at its features! They'll convince you that once more, RCA combines the finest quality with the greatest value!

*Only RCA Radio Tube Tester Offers
All These Features*

- 1 Test new 1-1/2 volt battery tubes.
- 2 Tests every standard type of receiving tube including all ballast tubes. Also tests cathode ray tubes for shorts and emission. All tests made according to RMA standards.
- 3 Tests four prong and octal base ballast tubes for noisy welds and opens.
- 4 Tests Magic Eye tubes for brilliance and opening and closing of eye.
- 5 Tests voltage drop on all types of Gas Tubes, such as OA4-G, OZ4-G, 874, and others.
- 6 Easily operated. All operating instructions and settings shown on simplified roller chart.
- 7 One Finger Operation. Buttons released or retained automatically as required for testing.
- 8 Shows line voltage up to instant of actual test. *Not necessary to set line voltage before inserting tube in socket.*

Easily Portable... Ideal for Service Work!

The large illustration at the top shows the RCA Radio Tube Tester as designed for counter use. Stock No. 156-A, net price \$37.95. The unit is also available with cover and snap-type handle for portable use. Stock No. 156, net price \$39.95.



*RCA 3" Cathode Ray
Oscillograph*

This is RCA's newest and finest general purpose 3 in. Oscillograph. Has many new features—all at an attractive price. Provides an easily read image without requiring expensive accessory equipment of larger tubes. All controls located on front panel. Sensitivity—20 volts (RMS) per inch deflection without amplifier—with amplifier, 0.5 (RMS) per inch deflection.

Stock No. 155—\$63.95 net

Over 325 million RCA radio tubes have been purchased by radio users . . . in tubes, as in parts and test equipment, it pays to go RCA All the Way.

RCA presents the Magic Key every Sunday, 2 to 3 P. M., E. S. T., on the NBC Blue Network

RCA Manufacturing Co., Inc., Camden, N. J.
A Service of Radio Corporation of America

**TWO
GUARANTEES**



It takes two guarantees to insure a profitable tube sale. Guarantee of quality protects the customer, but that's only half of it. The dealer, too, must be guaranteed against unnecessary investment, dead stock, obsolescence, cut price competition, all of which make losses instead of profits.



Dealers, who have qualified, know that the Tung-Sol Compensation Plan insures their continued profits just as Tung-Sol Tubes insure their customers' continued satisfaction.

Any Tung-Sol jobber or branch office will gladly give you details.

TUNG-SOL
Tone-flow Radio Tubes

TUNG-SOL LAMP WORKS, INC.
Radio Tube Division
Dept. B

Sales Offices: Atlanta • Chicago • Dallas • Denver • Detroit
Kansas City • Los Angeles • New York • General Offices: Newark, N. J.

Flash from Magnovox, of Fort Wayne brings word that their line of Molanode Capacitors announced early this year now are available in tubular type . . . Philco announces a 12 ft. vertical and easily installed safety aerial . . . With the addition of the N mounting to established A and B mountings, transformers by Robert M. Hadley Co., Los Angeles, cover needs of majority of service applications . . . Briggs & Stratton, Milwaukee, announce an electrically started battery-charging plant, 300 watt capacity, which charges 12, 6 and 2 volt batteries.

Prevue of New

GAROD

Garod Radio Corp.
115 Fourth Ave., New York, N. Y.



MODEL 4159—A 15 tube superhet a.c. receiver with Prestomatic 8 button instantaneous tuning over 4 bands. R.f. pre-amplifier stages on all bands insure selectivity, automatic bass compensated volume control, slide rule dial.

PHILCO

Philco Radio and Television Corp.
3701 N. Broad St., Philadelphia, Pa.



MODEL 7C—Distinctively styled two-tone walnut cabinet with oval dial, this 5-tube superhet offers six push-buttons and standard and short wave broadcast bands.

ADMIRAL

Continental Radio and Television Corp.
3800 Cortland St., Chicago, Ill.

RECORD PLAYER—Model AW-11 is completely portable with no wired connection between player and radio. Plays up to 12 in. records. Self-starting motor, automatic stop, off and on pilot light, 2 position power control switch.



AUTO-RADIO—Model 921 is equipped with five tubes, offers full vision illuminated dial, 5 in. electro dynamic speaker, automatic volume control. Easy mounting with Philco universal adjustable bracket. List \$24.95.

STROMBERG-CARLSON

Stromberg-Carlson Tel. Mfg. Co.
100 Carlson Road, Rochester, N. Y.



RECORD PLAYER—Can be attached to practically any receiver. Plays 78 r.p.m. records up to 12 in. Volume control, adjustable automatic stop, crystal pick-up, constant speed motor.

STEWART-WARNER

Stewart-Warner Corp.
1826 Diversey Parkway, Chicago, Ill.

RECEIVER—True fidelity reproduction of a broad tonal range and simplicity of control came first in design of a receiver for the exacting music lover. Eight station push button tuning, no manual tuning. Hand rubbed mahogany cabinet.



Radio Merchandise

Comes word that Littlefuse Laboratories, Chicago, contribute Tattelite Tester to show live or open circuits, blown fuses, defective condensers and resistors, grounded lines, a.c. or d.c. current and approximate voltages . . . From formulas used in its cabinet factory, comes RCA'S furniture polish, does a cleaning as well as polishing job . . . World's Fair Cine "8" movie camera made by Universal Camera Corp., New York, has 5.6 lens, retails in the lower price brackets . . . Radio City Products, New York brings out an a.c.-d.c. multitester with a 3 1/2 in. D'Arsonval movement, accurate within 2 per cent.

HALSON

Halson Radio and Television, Inc.
Meriden, Conn.

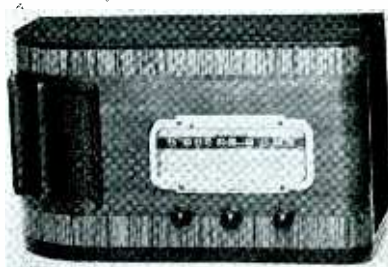

MODEL 10— Mounted in walnut cabinet trimmed with contrast bands of burl walnut, features Halson Bellying Tone. Six tube a.c.-d.c. superhet, six in. loudspeaker, tone control, beam power output, broadcast and short-wave bands. List \$34.50.

RCA

R C A Manufacturing Co.
Camden, N. J.



BATTERY RECEIVERS— Model 94BK-2 shown is selected from R C A's new dual line of battery receivers. One group employs 1 1/2 volt tubes, the others are 6-volt operated. The model illustrated employs push-button tuning, gives American and foreign reception.

BRUNSWICK

Brunswick Radio Div., Mersman Bros. Corp.
206 Lexington Ave., New York, N. Y.

MODEL 3689—Another of Brunswick's line of radios in fine period furniture, the half round cabinet of this 6 tube a.c. superhet could be used as one of a pair of French Commodes. Six push-button tuning, beam power output, automatic volume control.



MAJESTIC

Majestic Radio and Television Corp.
2600 W. 50th St., Chicago, Ill.

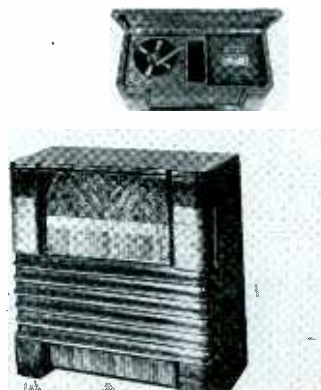

COMBINATION — Model 699P—Six tube superhet radio-phonograph with 3 band, 6 button mechanical tuning, automatic volume control. Phonograph has crystal pickup, self starting motor, automatic stop, and plays 12 in. records.

WILCOX-GAY

Wilcox-Gay Corp.
Charlotte, Mich.



RECORD PLAYER—Wireless, requires no connection between player and radio, works with any radio, needs no change in radio chassis. Radiation from unit may be picked up on an unused radio channel a maximum distance of about 20 feet.

HOWARD

Howard Radio Co.
1731 Belmont Ave., Chicago, Ill.

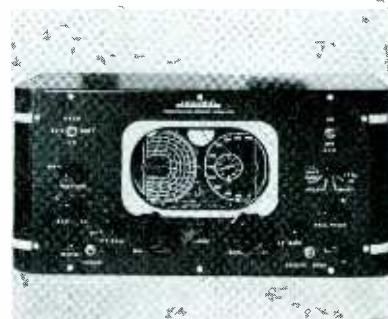

MODEL 450— Communications receiver with novel micrometer type dial. "R" meter, adjustable band width, built-in crystal filter, beat frequency oscillator, injection and pitch control, send - receive switch.

PREVIEW OF NEW RADIO MERCHANDISE

CLARION

Transformer Corp. of America
69 Wooster St., New York, N. Y.

SOUND SYSTEMS — C462 and C458 assemblies include 30 watt beam power amplifier, tubes, 12 in. P.M. speakers, cable, chrome mike stand, carrying case, choice of microphones. Model C-462 carries in addition a dual channel remote control box and cable.



OPERADIO

Operadio Manufacturing Co.
St. Charles, Ill.

AMPLIFIER — Model 855-R is a six stage base or semiportable type amplifier, offers 4 channel input, volume expansion, volume compression, electronic visual overload indicator, electronic visual output level indicator, and provision for Remote Control.



SPRAGUE

Sprague Products Co.
North Adams, Mass.

CONDENSERS — In two physical sizes; in capacities from 5 to 5000 mmf. these silvered mica condensers are of use in r.f. and permeability tuned i.f. circuits. Can be used with Sprague Compensating Condensers where precise value of capacity and negative value of drift with temperature necessary.



VOCAGRAPH

Vocagraph Sound Systems
164 N. May St., Chicago, Ill.

AMPLIFIERS — In the lower price brackets 40 and 100 watt output amplifiers by Vocagraph offer built-in four channel pre-amplifier and electronic mixers, employ 17 tubes, dual stage electronic tone compensator, push-pull drivers, separate rectifiers for plate, grid and screen voltages.



RADOLEK

The Radolek Co.
601 W. Randolph St., Chicago, Ill.

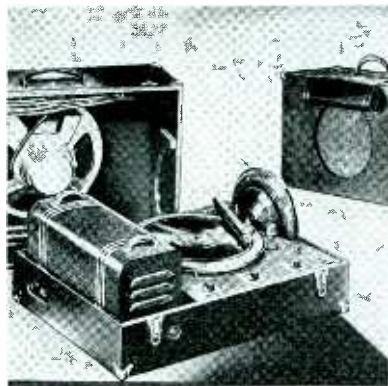

P. A. SYSTEM — For convenience in installations in portable sound systems, 25 watt P.A. system affords high fidelity, 130 db. gain amplifier with dual mike input, phono input mixing and fading facilities, record player, mike, stand and speaker all in one carrying case.

AMERICAN

American Microphone Co., Inc.
1915 S. Western Ave., Los Angeles, Calif.

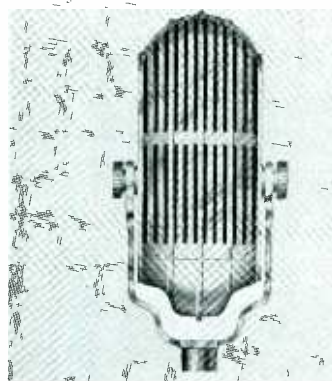

MICROPHONE — D9 dynamic, a pressure velocity microphone with pickup from one side only, is designed to reduce feed-back and to provide a unidirectional pickup with good response and relatively high output. \$37.50.

NOTICE

To Dealers in All Cities Under 25,000 Population ONLY

(Dealers in larger cities—Please *do not* apply, as all metropolitan territories are definitely closed)

ARGUS PHOTOGRAPHY

— the outstanding merchandising success of the year is now being made available to alert merchants in smaller towns.

Over 1,000 large city dealers now making extraordinary profits on Argus—the largest selling miniature camera in the World.

Ask any Argus dealer to tell you of the profits he is making. Write today for special booklet explaining this important merchandising opportunity, showing how a very small investment will add to your profits.

Only a limited number of Exclusive Argus dealerships now available. *If you are an aggressive merchant in a good location, write at once . . . as all territories are expected to be closed in sixty days.*

INTERNATIONAL RESEARCH CORPORATION
246 FOURTH STREET • ANN ARBOR, MICH.

WEBSTER-CHICAGO

The Webster Co.
5622 Bloomingdale Ave., Chicago, Ill.

MODEL 2 L 1 8 — Churches, lodges, theaters requiring good reproduction employ this 18 watt P.A. system. Four-stage, seven tube amplifier, multi-stage degeneration, phase inversion type.



WHY WE SAY

"See Operadio Speakers"

BEFORE YOU BUY



Whether you be jobber, dealer, or serviceman, **OPERADIO** offers you in its complete line of **PUBLIC ADDRESS** and **RADIO REPLACEMENT SPEAKERS** and **UNI-MATCH TRANSFORMERS** . . . a line that enables you to make immediate delivery . . . give maximum service with any impedance that may be required . . . **FROM STOCK** and from a **GREATLY REDUCED INVENTORY**.

This is made possible by the unique design of the new **UNI-MATCH** Transformers and the fact that the Speakers themselves are of the direct-to-voice coil type.

All you need do is mount the new **Uni-Match Transformer** on the Speaker by means of two self-

tapping screws, match the Speaker to any desired impedance by a simple adjustment of the **ROTARY SWITCH**★ on the terminal strip, connect the lead and the Speaker is ready to go . . . to give the quality of sound for which Operadio is famous. As many as six Speakers can be used with the identical transformer.

See your jobber or Address Dept. RR10 for Speaker Catalog

Manufacturers of a complete line of Public Address Equipment, Intercommunicating Systems, School Sound Systems, Public Address and Radio Replacement Speakers.

DID YOU KNOW

that Operadio is probably the world's largest speaker manufacturer. Our sales for the past five years have averaged over a million speakers per year. Radio set engineers have rigid standards. They insist upon a good speaker for a good radio set. Chances are that the quality radio sets you have on your floor are equipped with Operadio Speakers.

★The Rotary Matching Switch, exclusive with Operadio, is a very quick, convenient way to establish a proper match.

Export Division:
145 W. 45th St., New York City

OPERADIO

All Operadio Systems are Licensed by Electrical Research Products Inc. under U. S. patents of American Telephone and Telegraph Company and Western Electric Company, Incorporated.



OPERADIO MANUFACTURING COMPANY ST. CHARLES ILLINOIS

PREVIEW OF NEW RADIO MERCHANDISE

STANCOR

Standard Transformer Corp.
1500 N. Halsted St., Chicago, Ill.

TRANSMITTER KIT — Model 20-P is reasonably priced, portable and self-contained. Complete phone and c.w. transmitter including power supply, is crystal controlled and will operate on any frequency from 1.6 to 60 m.c. Meter switching for important circuits, oscillator keying allows break-in operation.

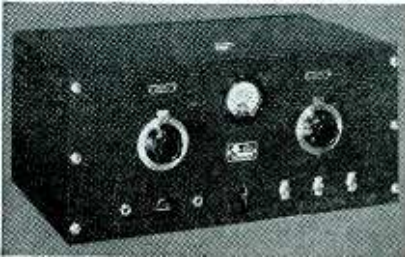

OHMITE

Ohmite Manufacturing Co.
4835 Flournoy St., Chicago, Ill.



RESISTOR — D-100 dummy antenna resistor rated 73 ohms, 100 watts, built like a vacuum tube with glass bulb and 4 prong ceramic base, mounts on standard tube socket. A power size low inductive and distributed capacity resistor which provides method of checking transmitter output and efficiency.

SPRAGUE

Sprague Products Co.
North Adams, Mass.



CAPACITORS — Type DR paper condensers are made in capacities of 4, 8, 4.4 and 8.8 mfd. Appearance similar to that of standard electrolytics with capacity 1/3 to 1/2. No polarity to observe, 600 volt rating.

HYGRADE-SYLVANIA

Hygrade-Sylvania Corp.
500 Fifth Ave., New York, N. Y.

STOCK BOY CABINET — Additions to Sylvania's Stock Boy Cabinet make it even more useful to service men. Display shelves for tubes, partitioned storage space drawers, storage bin for heavy articles, cash box, bookends solve the problem of keeping service material close at hand.

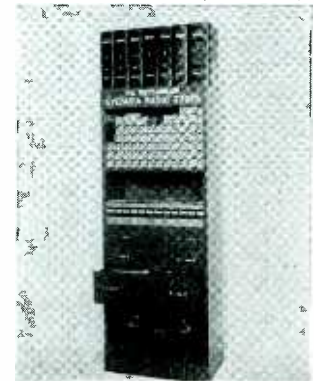

CLOUGH BRENGLE

Clough-Brengle Co.
Chicago, Ill.

No. 285 UNILYZER — combines plug-in socket analyzer and point to point unimeter with 29 ranges including capacity and output in a.c. volts or decibels. Function switch automatically shuts off receiver power when thrown to resistance or capacity position.



"HAMBAND"

P. R. Mallory and Co., Inc.
Indianapolis, Ind.

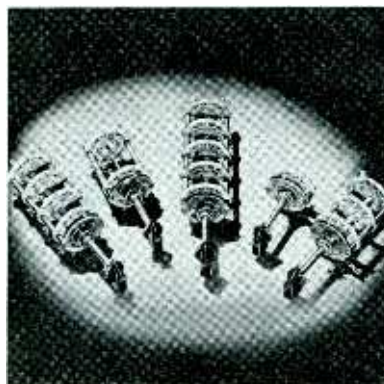

SWITCHES — Distinguished by low-loss impregnated magnesium-silicate ceramic insulation, convenient contact spacing for short direct leads, continuous rotation.

C-D

Cornell Dublier Electric Corp.
South Plainfield, N. J.



CAPACITORS — TQ series of transmitting capacitors are hermetically sealed in round drawn aluminum containers, are impregnated and filled with high dielectric strength Dykanol, which is non-explosive and non-flammable. Available in 1 or 2 mfd from 600 to 2000 volts.

EX-STAT

Tilton Electric Corp.
15 E. 26th St., New York, N. Y.

RESISTORS AND CABINET — Steel cabinet with 5 partitioned drawers supplied with 250 or 500 Ex-Stat insulated 1 watt resistors which have ceramic insulation and cement filled ends. Color coded and stamped with value.



TUBEMASTER

John Meck Instruments
164 N. May St., Chicago, Ill.



TESTER — Determines dynamic performance of tubes, giving in a single reading dynamic mutual conductance and power output. Illuminated ten inch roll chart for test data, operation requires only 4 selector switches. Pattern 20, \$29.50 net to dealers.

SOLAR

Solar Mfg. Corp.
599 Broadway, New York, N. Y.

MINICAP—Ultra compact dual unit dry electrolytic is permanently sealed; is made in practically all commonly used values.



IRC

International Resistance Co.
401 N. Broad St., Philadelphia, Pa.

RESISTOR — Spiral formation of the "Metalized" Resistance element on a ceramic base provides long current conducting path and allows use of voltages up to 100,000 at 150 watts or more on 18½ in. x 2 in. tubes. Units rated at 5,000, 10,000, 25,000, 50,000 and 100,000 volts



JANETTE

Janette Mfg. Co.
556 W. Monroe St., Chicago, Ill.

CONVERTERS —Changes d.c. to a.c. for radio-receivers, amplifiers, phonographs, sound pictures and other similar uses. Available in various wattage sizes for loads of 85 to 100 per cent power factor. Special radio filter designed for quiet reception from 500 to 30,000 kc.



AEROVOX

Aerovox Corp.
70 Washington St., Brooklyn, N. Y.

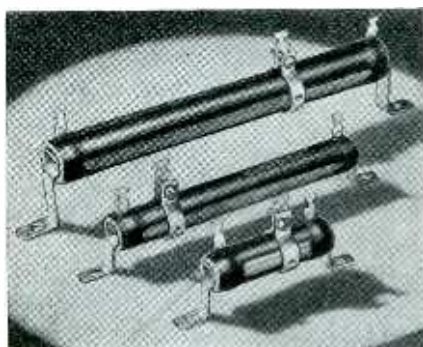

RESISTORS — Pyrohm, Jr., and Slideohm resistors cased in vitreous enamel employ low temperature coefficient wire wound on refractory tubing. Pyrohm supplied in 10 and 20 watt sizes and wide range of resistance values. Slideohm available in 25, 50, 75, 100 and 200 watt ratings with 1 slide band. Slideohm illustrated.

KISCO

Kisco Co., Inc.
St. Louis, Mo.

HEATER — "Deflecto Registair", easily attachable to any register, employs suction to draw heated air through the furnace pipe and circulates it in the room. In summer can be used to draw cool basement air to upstairs rooms. \$9.75.

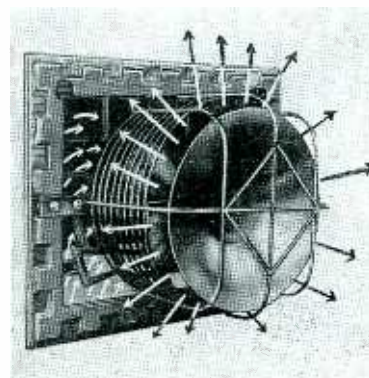

J F D

J. F. D. Manufacturing Co.
4111 Fort Hamilton Parkway, Brooklyn, N. Y.

ADJUSTABLE BALLAST UNITS—When adjusted these units are designed to deliver the exact voltage of the ballasts replaced, remain accurate permanently. Adjustment is simple, requires no tools.



STEEM-ELECTRIC

Steem-Electric Corp.
1726 Lafayette Ave., St. Louis, Mo.

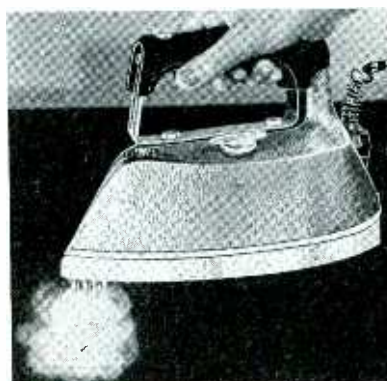

IRON — Water in self-contained water jacket ejects steam at point of the iron and eliminates necessity for sprinkling clothes. Allows steam treating of pile fabrics. Gives about an hour's service without refilling.

SELL COMBINATIONS Faster!

Test the Model V

Model V FLYER Motor, priced for large-volume use, has set-screw speed adjustment. Other models, with pointer-and-dial adjustment. Order samples to test out in your cabinets.

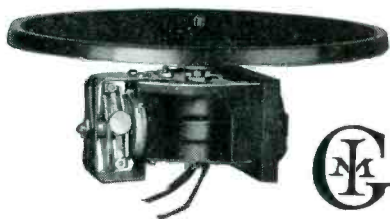

PUT the right power in your radio-phonograph combinations and go to town with volume sales. Equip your sets with FLYER Motors, for the utmost in uniform speed, quiet running and long service, with low motor and installation cost. Self-starting governor-controlled induction type. Silent, laminated bakelite gears running in oil. Long over-size bearings. Range in choice to meet your needs. Get your sets worked out NOW.

The **GENERAL INDUSTRIES CO.** 3837 TAYLOR ST.
ELYRIA, OHIO

NOW! A RADIO and TALK BACK SYSTEM Every School can Afford!

Now BELL brings you a quality-built Desk-Type Panel System especially designed to meet the demand for a low cost radio and talk-back system for schools, hotels and other institutions. It comes equipped with switches for ten rooms, and has provision for connecting up to 30 substations when desired! And note these additional features:

24 watt amplifier with bass and treble compensation . . . heavy-gauge steel construction cabinet finished in silver grey crackle baked at 300 degrees . . . provision for phono attachment . . . Audible monitor . . . Master switch for each panel of ten switches.



A BIG FIELD FOR PROFIT!

Think of the market for it! A public address system, intercommunication system, and radio—with provision for phonograph attachment—all in one! And at a price all can afford! A great new field of profit for you! Write today for complete information.

BELL Sound Systems, Inc.

1185 ESSEX AVE.

COLUMBUS, OHIO

Export Office: 108 W. Washington St., Chicago, Ill.

NEW UNIVERSAL FULL FREQUENCY CUTTING HEAD

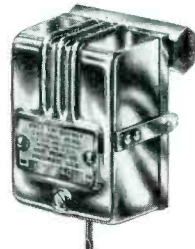

U. S. Patent
No. 2005154

The PERFECT electrically, magnetically and mechanically balanced cutting head. Produces clear crisp recordings—brilliant highs and full bass. No rubber or substitutes, nothing to deteriorate. Guaranteed day in and day out for uninterrupted service every day for years. Records freq. 30 to 10,000 cycles and over. Impedance 15 ohms. Requires + 14 db. input level, 2 or 3 watts. Climatically sealed. For replacement or new installations.



Universal Microphone Co., Ltd.
INGLEWOOD, CALIFORNIA, U. S. A.

EXPORT AGENTS - FRAZAR & CO. 7 FRONT ST. SAN FRANCISCO

Janette Rotary Converters

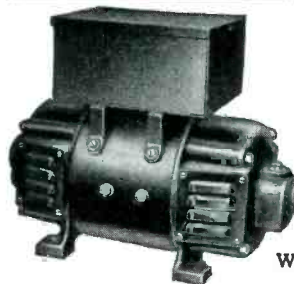

For Converting D.C. to A.C.

Built for radio and sound apparatus—capacities 110 to 3250 volt amperes—with or without all wave filters. Dynamotor construction—economical to operate—ruggedly built for years of trouble-free service—used or recommended by the largest manufacturers of radio and sound apparatus—in use all over the world.

Why Experiment—Insist on a Janette

Ask for Bulletin 13-25

Janette Manufacturing Company

556-558 West Monroe Street Chicago, Ill. U. S. A.

A GOOD NAME GOES A LONG WAY



The wise service man uses "good name" parts for necessary repair work. The dependability of KenRad Radio Tubes is known the world over.

Ken-Rad Tube & Lamp Corp.
Owensboro, Ky.

KEN-RAD

DEPENDABLE RADIO TUBES

HOW FAR AWAY

(Continued from page 18)

ads, a truck with a large sign, and donates the use of a P.A. system to an amateur girl's soft-ball team which regularly draws night crowds of 2,000 to 5,000 baseball enthusiasts. A "commercial" announcement each inning plugs the shop.

Further expansion of Emergencv's business which might result from a broader distribution of advertising would probably draw trade from an area too far from the shop to be handled profitably. A branch store located two or three miles north would be one logical expansion method to undertake as the area south of the shop goes into an industrial and foreign residential district which is inclined to patronize shops operated by people of their own nationality.

* * *

Coordination of these business analyses and mutual working agreements between their several operators would cut out service calls which are too far from the bench to be profitable, according to the Business Research Bureau of the American Radio Association, responsible for the survey. Comparative freedom from overlapping clientele would justify cooperative advertising in the citywide distributed classified 'phone book and in larger newspapers.

Strange as it may seem, each of the operators who volunteered to submit records for the survey were under the impression that they had citywide clientele which justified advertising far beyond their trading areas. The analysis has corrected this impression and clearly defined their market as essentially "neighborhood."

AIR CONDITIONING

(Continued from page 22)

start featuring air-conditioning is not likely to produce maximum results. The average ratio of sales to prospects unearthed in cold weather and followed up in spring is 1 to 8, report the dealers interviewed.

Displayed in a show window, the air-conditioner has abnormally high pull-in power. The high ratio of sales to prospects is due to the fact that many prospects are "walk-ins," who evince considerable interest.

The dealer should survey the

room or interior before quoting price. The type building, number of windows, number of people frequenting an interior, location of room and other factors affect installation requisites so that the dealer is in for trouble if he quotes prices or makes installations without adequate surveys, particularly where units are sold on credit. If conditioners do not cool adequately because of undersize, users will either demand correction or may discontinue payments.

On household, office and small store jobs, dealers say that installa-

tion technique does not involve difficulties that the average radio retailer cannot solve. Air-conditioning engineers have simplified such equipment so that hook-up is simple, likewise the survey prior to hook-up. If a problem perplexes, the manufacturer or distributor will aid. Space coolers, spot coolers, room coolers or unit conditioners are now packaged jobs, as easy to install and service as radios, unless the dealer goes after business over 5 tons, and this he should not do unless he has adequate engineering facilities.

Where outside salesmen are em-

Step Up! Equip Yourself for More Business the NATIONAL UNION WAY



Thousands of Radio Service Engineers are aggressively stepping ahead for more business again this year, equipped to get it with latest instruments. They're getting these instruments free the easy N. U. way. Why don't you?

National Union provides equipment to fit every dealer's needs. You can have the things you need to get more business free with purchases of N. U. quality products. Ask how . . . do it now!

Come on! Build Customer Confidence with NATIONAL UNION Quality Tubes—Condensers

WRITE FOR DETAILS and NAME of NEAREST DISTRIBUTOR

**NATIONAL UNION RADIO CORP.
NEWARK, N. J.**

"PINCOR" POWER SUPPLY UNITS



DYNAMOTORS GEN-E-MOTORS CONVERTERS

"PINCOR" dynamotors, gen-e-motors and rotary converters provide the last word in power supply units for air craft, police, marine and auto radios; also for public address systems. Now widely used by leading air lines and municipal and federal agencies throughout the world. Available in a wide range of capacities for every requirement. Compact, light-weight. Sturdily constructed to assure long dependable service. Write for catalog and complete information.

PIONEER GEN-E-MOTOR CORP.
Manufacturer of "PINCOR" Products
Dept. R-1J
466 W. Superior Street, Chicago, Illinois

**OTHER
"PINCOR"
PRODUCTS**
BLUE DIAMOND and GOLD CROWN gas-engine driven electric light and power plants up to 5000 watts; alternating or direct current; air or water cooled; remote control. Send for literature.



Get Volume Sales On
Record-Changer Sets
That Average Folks
Can Afford



Low Additional Cost Over Hand Changing

MEET the natural demand for automatic record playing without high cost. Sell the homes of moderate means that build volume sales. Install General Industries Record Changer Units in your radio-phonograph combinations.

Model "M" shown above plays and changes eight 10-inch or seven 12-inch records, repeating the last. Has famous Flyer Motor with turntable and pointer-and-dial speed adjustment. Dependable, simple, smooth-working record changer. High-fidelity pick-up. Comes to you a completely assembled, self-enclosed unit ready to install in cabinet with low labor cost.

Write today for full information. Order sample Model "M" to test.

The GENERAL INDUSTRIES CO.

3837 Taylor St.
Elyria, Ohio

LOW PRICE

...is only one reason why
**YOU'LL SELL LOTS OF
THESE RCA MIKES!**

RCA JUNIOR VELOCITY MICROPHONE



Recommend this mike to those who want the best at low cost. It's the finest popular priced microphone RCA has ever created. Provides peak performance, is attractive, and offers the rugged construction and long life of RCA Velocity Microphones. Alnico magnets are used to provide exceptionally high signal-to-noise ratio. Is adaptable to most input circuits because of three output impedances. And it costs only \$43.50 list, less stand.

RCA AERODYNAMIC MICROPHONE



Here's a P. A. winner! It costs only \$26.50 list, less stand. Is so small it can be easily carried in the palm of your hand. Yet has quality features including excellent frequency response, fine tone and high sensitivity. Is used to good advantage for close talking. Has new Alnico permanent metal magnet. Requires no external excitation of power.

See your nearest RCA Commercial Sound Distributor for the new RCA Sound Catalog, or write direct to the address below.

ANY SOUND SYSTEM SOUNDS BETTER EQUIPPED WITH RCA RADIO TUBES

Listen to the "Magic Key" every Sunday,
2 to 3 p.m., E. S. T., on NBC Blue Network



Commercial Sound

RCA MANUFACTURING CO., INC., CAMDEN, N. J.
A Service of the Radio Corporation of America

UNIDIRECTIONAL DYNAMIC D9T

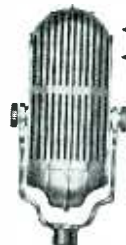

← BACK No Pickup
← FRONT Full Coverage

**VOLUME INCREASED
by Reducing Feedback**

D9T, list \$37.50 High Imp. 25' Cable

D9, list \$35.00 Low Imp. 25' Cable

Write for Catalogue No. 29

Manufacturers Full Line Dynamic, Crystal, and Carbon Microphones and Stands

AMERICAN MICROPHONE CO., Inc.

1915 So. Western Ave., Los Angeles, Calif.



B9
Crystal
List
\$22.50



D5T Dynamic
List \$32.50

Cash In On The New

RALSTON RADIO CODE COURSE

This modern development in code education will dominate the field. Three double-sided recordings with excellent instruction book comprise a THOROUGH—SIMPLE—ACCURATE method to learn radio code in Half the Usual Time.

For Quick Profits

Play these records in your store—they will sell themselves. List price complete ONLY \$8.00.

Write today for complete information

RALSTON RECORD COMPANY

5433 Willows Ave.

Philadelphia, Pa.

ployed, air conditioning is a welcome added offering. Refrigeration men break in readily. In a few cases sound salesmen contacting offices and stores solicit air-conditioning business with varying degrees of success. It was the consensus of opinion that most sound salesmen could add air-conditioners with profitable aftermath because of the type of contacts they make. Office executives and other prospects interviewed on sound may be induced to plus these purchases with room coolers for homes, offices or stores.

Salesmen carry no demonstrators. It is a showroom demonstrating proposition. Dealers successful with this line have at least one unit hooked up on the sales floor. Some display this item but it is not hooked up. A conditioner in actual operation has at least twice the buy appeal of a dead unit, say dealers who have tried both ways.

RECORDS FOR SOUND

(Continued from page 23)

of the old south could be lightened by the use of Stephen Foster melodies at appropriate times, between the acts and at intermission.

It is essential that care be taken in the selection of these records to secure discs with little or no vocals for the reason that the vocal might distract the audience from the player's action on the stage.

The following are representative of this class of interlude music:

- Liebestraum
- La Golondrina
- Indian Love Call
- World is Waiting For the Sunrise
- In a Monastery Garden
- Auf Wiedersehen
- Auld Lang Zyne
- My Old Kentucky Home
- Oh Susanna
- Old Black Joe
- Way Down Upon The Swanee River
- Blue Danube Waltz
- Tramp, Tramp, Tramp
- Tenting Tonight
- Marching Through Georgia
- Dark Eyes
- Two Guitars
- La Paloma
- Cielito Lindo
- Inspiration, Tango
- Old Man River
- Summertime

Many other selections could be added to form a complete library. The above will serve for the average dramatic presentation.

Don't Pass Up Sound Effects

It is, of course, possible to offer a recorded library without sound effects that will suffice along general rental lines, but every year more and more attention is being

paid to the science of sound effects, as the public has been educated to expect these background interludes through radio. Amateur plays and similar dramatic offerings reach their peak in the coming winter season, when outdoor sound work declines.

Everyone is familiar with the photos which have appeared in *Radio Retailing* showing how the major networks make their sound effects. Unless the soundman wishes to have two Mack trucks to cart around this equipment, the logical and only choice is recorded sound effects.

A sound effect is available for practically every known sound or series of sounds. While a sound effect library may assume the proportions of a veritable room-filled layout, the following effects are generally adequate for use by the average dealer in conjunction with rental installations:

Necessary

- Telephone Bell
- Fire Engine Bell
- Siren
- Applause
- Thunder

(Please turn to page 82)

A Plain Statement of Fact Concerning DYNAMIC MUTUAL CONDUCTANCE

Important Information for the Protection of the Radio Service Industry.

Meter used in HICKOK T-53 TUBE TESTERS. RANGE: 0-3000-6000-15,000 MICROMHOS.

A
TUBE TESTER TO TRULY MEASURE DYNAMIC MUTUAL CONDUCTANCE SHOULD READ IN

MICROMHOS



JUST AS A WATTMETER READS IN WATTS OR A VOLTMETER IN VOLTS

The Standard Unit of Measurement of Mutual Conductance is the Micromho

Dynamic Mutual Conductance in Micromhos is the accepted method of tube testing among all manufacturers and tube engineers. Hickok has pioneered and perfected Dynamic Mutual Conductance Tube Testers for the past fifteen years. An accurate, modestly priced tester is the result.

Hickok has also pioneered these advanced designs: Zero Current Voltmeters—infinite ohms per volt; Signal Generators with power level meter and output calibrated in microvolts; Oscillographs with built-in modulators and demodulators and video amplifiers; New Crystal Controlled service generators. Fill out the coupon below.

THE HICKOK ELECTRICAL INSTRUMENT CO.
CLEVELAND, OHIO

The Hickok Electrical Instrument Co., 10513 Dupont Ave., Cleveland, Ohio

Gentlemen: Please send information on—

- Dynamic Mutual Conductance Tube Testers.
- Calibrated output and crystal controlled Signal Generators.
- Zero Current Voltmeters.
- Giant Volt-Ohm-Milliammeters.
- Other Apparatus as follows—

Name

Address

City..... State

SEE for Yourself!

The RIDER Chanalyst



Sensational Trouble-Shooting Instrument Now Being Demonstrated By Your Jobber

See How you can check any point in the receiver, no matter what it may be, simply by placing the proper probes at the points under test!

See How you can determine the existent trouble, almost immediately, by merely moving the probes from one point to another!

See How you trace the passage of the signal through the receiver and establish the points where signal exists, becomes distorted, fades, dies, takes on hum, without interfering with the normal operation of the receiver!

See How any and every check of the operation of the audio-frequency channel is made with the use of a single probe!

See How the Electronic Voltmeter enables you to measure all d-c voltages in any part of the receiver by the use of only one probe in conjunction with a common ground.

See How you can conduct any and every test in the RF and IF channel, easily, quickly and accurately!

See How the oscillator channel is checked by placing the proper probe in contact with any portion of the oscillator tuned circuit and resonating the channel to the frequency of the signal being generated by the oscillator.

See How the Intermittent Problem is solved with the Rider Chanalyst... How you can, in effect, divide the receiver into five separate sections, and definitely localize the trouble as being in a certain part.

See The multitude of other tests you can conduct with the Rider Chanalyst. It involves no unknown principles of radiol

See This sensational new instrument demonstrated by your jobber.

SERVICE INSTRUMENTS, INC.
404 FOURTH AVENUE • NEW YORK CITY



SEE IT DEMONSTRATED TODAY



JOHN F. RIDER
in whose Successful Servicing Laboratories this revolutionary instrument was developed.

Free
16-PAGE
DESCRIPTIVE
BOOKLET
SENT ON REQUEST

PREMAX

The Original
Vertical Steel
Antenna

**Strong! Husky!
Dependable!**

**24 Feet For Good
Reception!**

Telescoping steel tubing in 6' units, extends to 24', easily, quickly, securely. Mount on roof or ground. Adaptable to RCA Magic Wave Antenna.

For real satisfaction, sell the **PREMAX VERTICALICAL**. Write for Bulletin and Prices TODAY.



Premax Products
Division of Chisholm-Ryder Co., Inc.

3013 Highland Ave., Niagara Falls, N. Y.

Investigate -

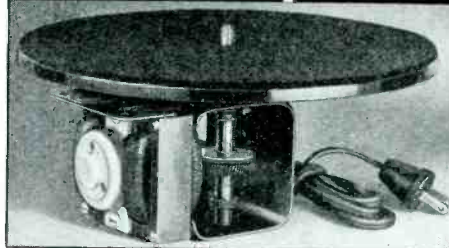

**This New "EVEN SPEED"
PHONOGRAPH MOTOR**

The new, more compact Alliance "Even Speed" motor is way ahead of anything in its field. Alliance engineers have eliminated the need of a governor yet the "Even Speed" motor maintains constant speed regardless of variations in record drag, line voltage or operating temperature. Large bearings with ample oil reserves and laminated bakelite-helical cut gears assure a long life of smooth, silent operation. The "Even Speed" motor (110 volt-60 cycle) is available with 9"-10" or 12" turn-tables and is furnished complete with 5' cord and rubber spools for mounting.

Write today for sensational, low prices and more complete information.

ALLIANCE MFG. CO.
ALLIANCE, OHIO

SERVICING HOME CHARGERS

By
H. D. HOOTON

THE successful operation of any piece of machinery, particularly a 6 or 12 volt d.c. electric generating set, depends very largely on proper installation under conditions that are favorable for economical and efficient operation. Therefore, the following points should be considered before a charger is to be permanently installed or if an installation develops trouble.

All gasoline motors develop heat and require a certain amount of fresh air circulation. It is absolutely necessary for this air to be as free as possible from dust and dirt; dirt in the motor or gasoline tank will cause trouble and serious damage will result if this condition is allowed to continue for any length of time. Adequate ventilation must be provided; otherwise the motor will overheat, especially when running for long periods or when it is heavily loaded.

Choose a location that is fairly dry and well protected against the elements. Excessive moisture will cause a rapid deterioration of generator and ignition parts. The batteries will freeze when discharged unless they are protected against low temperatures.

All d.c. plants, especially the small portable 6 and 12 volt types, should be located as near the load as is practical. Electrical wiring offers a certain amount of resistance to the flow of current, causing a voltage drop. In these low voltage systems even a fraction of a volt is a large percentage of the total supply and will cause an appreciable decrease in the charging rate. If the line wires are made excessively long or wire size too small, the voltage available at the battery terminals may be too low for practical charging purposes. The wire sizes and lengths given in the following table are based on the average installation to provide best results. The circuit wiring is shown in Fig. 1.

Circuit	Wire Size	Diameter	Max. Length
(a) Charger leads to battery	No. 4	0.2043"	6 feet
(b) Charger leads to battery	No. 6	0.162 "	3 feet
(c) Battery to fuse block	No. 6	0.162 "	25 feet
(d) Each line from fuse block to radio, lights, etc.	No. 8	0.1285"	25 feet
(e) Drop cords, floor lamps, table lamps, etc.	No. 14	0.041 "	3 feet

The length of each circuit is measured from the battery or battery leads

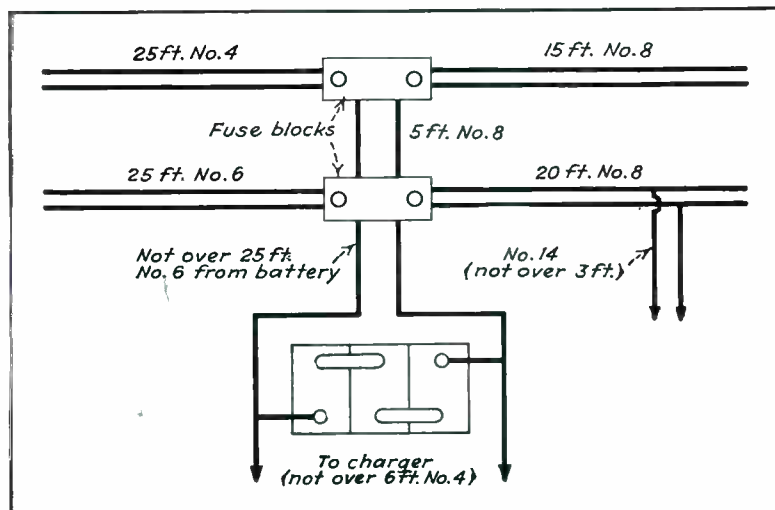

FIG. 1— Maximum circuit lengths for 6 and 12 volt d.c. installations.

through the fuse block to the end of each branch. As shown in the above table, not exceeding 25 feet of No. 6 wire may be used from the battery to the fuse block; from the fuse block use No. 8 wire for each separate branch, but not more than will make the total length of any circuit in excess of 50 feet including the No. 6 wire from the battery. If longer wiring is required, it will be necessary to use a larger size of wire in order to keep the line losses down to the minimum. The shorter the No. 6 wire between the battery and the fuse block, the longer the No. 8 wire circuit can be. In the event that less than 25 feet

of No. 6 wire is used between the battery and the fuse block, correspondingly longer No. 8 branch leads may be used.

The generator used on most chargers is a special high efficiency bi-pole, two brush, shunt wound, air-cooled type and, on the smaller 6 volt portable plants, has a maximum rated hot output of 7.5 volts at 14 to 25 amperes when driven at 2200 to 2300 r.p.m., the output rating is measured at the battery terminal relay. The generator may or may not have a special series winding which acts as a cranking motor on the self-starting types. In some models the armature has no end bearings, the armature shaft being in effect an extension of the motor crankshaft.

When bearings are used in the outer end of the armature shaft, they should be oiled approximately every 400 running hours. Use a good grade of S.A.E. 30 or 40 machine oil and drop five or six drops in the hole provided for this in the top of the hub of the cast iron bracket. Be careful not to drop too much oil in the oil hole. Oil or dirt on the commutator will affect the output of the generator by either reducing the output voltage or causing the current flow to be unstable.

Care of Commutator and Brushes

If inspection shows the commutator to be black or dirty, it can be cleaned and polished by holding a piece of number 00 sandpaper against it while the unit is running; do not use emery cloth. This can best be done by placing the sandpaper over the end of a stick cut square on the end. Have both the stick and sandpaper trimmed to

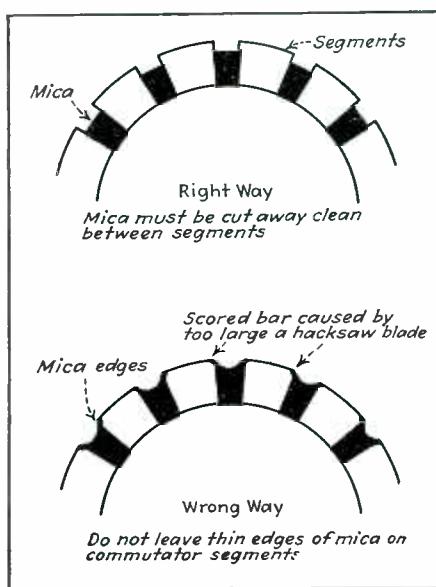

FIG. 2— Correct and incorrect method of undercutting commutator.

WORLD'S LOWEST-PRICED QUALITY TEST UNITS!

Push-Button Tube Tester

AN up-to-the minute push-button tube tester and tube seller for direct readings on all tubes, both metal and glass, a-c or battery types. Tests for quality, individual element leakage (both hot and cold); shorts, opens, noise and gas, all in accordance with highest engineering standards for emission testers.

A line-voltage control is included. Individual switch control of all elements takes care of "floating filaments" and other non-standard tube arrangements. Extra socket facilities and other ample provisions guard against obsolescence.

Fast, accurate, simple, the BERNARD TUBE TESTER uses no adapters.

Large 4" square illuminated meter, with provision for external use of the meter alone (0-1 ma). Tests include all the new tubes, among them television tubes, e.g., 18S1; the 1.4-volt, 50 ma and other battery tubes; gas tubes, such as 2A4G, 0A4G, 884, etc.; ballasts, magic eyes, etc.

Bernard Tube Tester, Model 387, shipping weight 9 lbs. Net price.

\$20⁹⁰

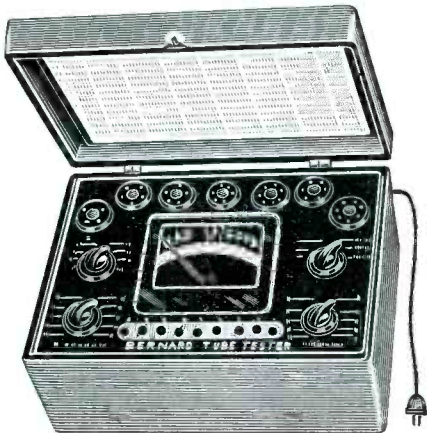

The impressive appearance inspires customer confidence; the rugged construction assures dependable service and long life. Removable cover makes same instrument applicable to counter or portable use.

Pocket-Sized 5,000-Ohms-Per-Volter

A POCKET-sized micro-multimeter, 14 ranges, using a 0-200 microammeter of 2% accuracy, in a 3" square Bakelite case, and housed in a most attractively finished cabinet. METERRITE JR. is an accurate, reliable instrument and the world's lowest-priced 5,000-ohms-per-volter! The meter scale is unusually extended for quick, easy reading.

With only 3 volts of self-contained flashlight battery (10¢ renewal cost), resistance is measured all the way to 2,000,000 ohms, and, on the low-ohms scale, down to one ohm. D.C. Voltage measured to 2500 volts. All Bernard instruments guaranteed.

Sweeping the Country!

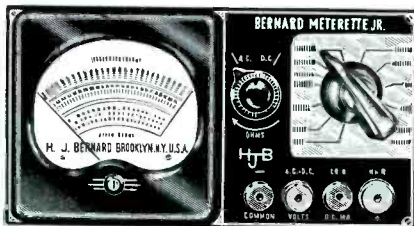

METERRITE JR. provides the following ranges:
0-10 - 50-250-500-2,500 ohms per volt
0-10-100-1000 volts a.c., all at 1,200 ohms per volt
0-200 microamperes (reads second detector diode current) and 0-10-100-1000 milliamperes (one amp.) d.c.
0-2,000 ohms and 0-2,000,000 ohms
(Bernard Meterette, Jr., Model 381-M; shipping weight 3 lbs. Net price)

\$10⁹⁰

Attractive appearance is combined with attractive price in METERRITE JR. There are only two controls, a feature of all Bernard multimeters.

GIANT Meter, 31 Ranges, Remote Control

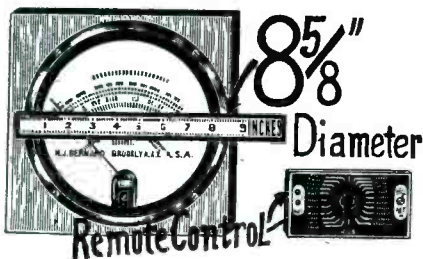

Outstanding in both price and performance, the Bernard Atlas uses a meter so large you can read it at a distance.

Model 388 Giant Multimeter, the Bernard Atlas; shipping weight 6 lbs.

THE BERNARD ATLAS, with GIANT-sized meter, costs about \$10 less than other apparatus using a large meter but ATLAS provides far more services. Unusual, highly-desired ranges are included, e.g., 150 millivolt a.c. output meter for connection across voice coils, so receivers may be aligned before the a.c. starts. You can see before you can hear! The tiniest hum can be read directly. One selector switch, one combination ohms-mfd.-henry adjuster, only two input posts. Meter hangs on wall, stands on shelf, lies flat or stands upright on bench.

RANGES:
0-10-50-250-500-2500 volts d.c., all at 1,000 ohms per volt
0-1-10-100-1,000 ma (one amp.) d.c.
0-40 ohms (20 ohms center) reads directly to .2 ohm; 0-400-25,000-250,000 ohms, with self contained battery; 0-2,500,000 ohms with external 45-volt battery (not supplied)
0-150 millivolts a.c. output meter
0-15-150 volts a.c. output meter (condenser self-contained)
0-15-150-1,500 volts a.c. (.002-.2 mfd.) (.02-2 mfd.) (1-100 mfd.) (.07-7 henries) (3.5-350 henries) (35-3,500 henries)
0-150 watts for a-c line
0-1-3 amperes a.c.
Three Db ranges, -10 to +58.

\$29⁹⁰
Net price

Treasure at the Price of Trash
See Your Jobber or Write for Catalogue "R"

BERNARD

H. J. BERNARD 319-R THIRD AVE. BROOKLYN, N. Y.
Export Representative: Pan-Mar Corporation, 1270 Broadway, New York, N. Y., U.S.A.

FOR
Less Surface Noise
Less Groove Wear
Better Reproduction
Greater Economy

USE

SUPERIOR

RECOTON

NEEDLES

This needle is made of a special steel alloy, highly polished, with the exclusive feature of a specially rounded point which does not shudder (and therefore does not damage) the record. 10 good plays from a needle... bringing out the finest in any record.

RECOTON Acoustic Needles

Where a louder reproducing needle is wanted, as when using portable or electric phonographs, we recommend this carefully inspected needle.

Samples sent upon request

RECOTON

CORPORATION
178 Prince St., N. Y. C.

INTER-COMMUNICATION SET

Plug-in and Talk • No Installation
• Fool Proof •

Fully Licensed and Guaranteed



Room to Room
Upstairs and
Down

House to House
Children's
Playroom

Nursery or
Playroom
House or Garage

Operates on 110 volts
AC or DC

#47 Master Unit
and Sub-Station
Complete with

Wire READY-TO-USE. Will operate efficiently with added wire up to 500 feet without additional attachments.

Weight 8 lbs. complete in air-cushioned cartons.

LIST PRICE
\$9.95

COMPLETE

Send for catalogue showing complete line up to \$79.50 list price.



REGAL AMPLIFIER MFG. CORP.

14-16 W. 17th St., New York
Cable Address "Ramecamp"

just the width of the commutator. If the commutator is worn rough or if the copper bars are worn flush with the mica insulation between the bars, the generator should be dismantled, thoroughly cleaned, the commutator turned in a lathe, undercut, and re-assembled. The truing up should be done at fairly high speed and a light cut should be taken with a sharp tool. The mica between the bars should then be undercut to a depth of 1/32 inch below the surface of the commutator bars by means of a hacksaw blade inserted into a file handle. The blade must have its teeth ground down until it is of the proper thickness in order that all the mica and none of the bars will be cut away between the segments as shown in Fig. 2.

The brushes should be cleaned free of all dirt and grease with gasoline or carbon tetrachloride. In order to clean the contact surfaces of the brushes and seat them properly against the commutator surface, place a strip of 00 sandpaper cut the width of the commutator around the commutator, sand side up. The sandpaper should lap twice around the commutator, sand side against the brushes. (Fig. 3) Pull the sandpaper tight with the brushes resting on it and then rotate the armature by hand in the direction in which it is driven. This causes the contact surfaces of the brushes to wear away, thus cleaning them, while the brushes are pressing against the commutator. Hence the curve of the brush is bound to be same as the contour of the commutator surface, so it will fit perfectly when the sandpaper is removed. The armature should be rotated until the brushes show a smooth even bearing surface over their entire face. Brushes not making a good contact with the commutator may be stuck fast in the brush holder. Loosen by tapping lightly and reseat if necessary. Brushes so worn that the brush spring arm almost touches its stop should be replaced. The brush spring tension should be adjusted to from 50 to 55 ounces when measured with a spring scale hooked under the brush spring arm close to the inside of the brush.

Service Kinks

If the ammeter does not show a charge with the unit in operation and the battery connected, the trouble may be due to: (1) Poor connections; (2) wrong or defective wiring; (3) dead battery cell; (4) generator brushes worn, dirty or not making contact; (5) dirty or worn commutator; (6) generator has an open field circuit; (7) generator armature burned out; (8) drive belt slipping; (9) motor and generator not up to speed. (10) Defective switch, circuit breaker or ammeter.

To locate the trouble stop the mo-

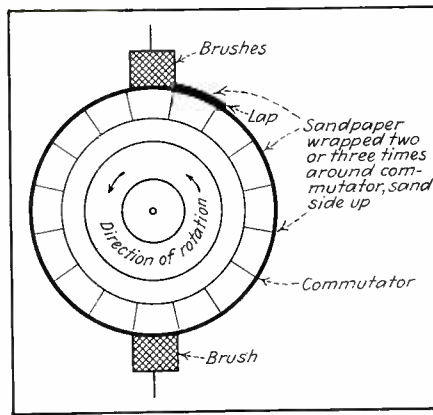

FIG. 3— Simple and effective way to reseat generator brushes.

tor and proceed as follows: Turn control switch to "start" position and if the gasoline motor is cranked electrically, numbers 1 to 7 inclusive above are O. K. If not, check the connections to the battery, the wiring, the generator brushes and commutator and the switch. If the motor starts and after it has attained normal running speed, the ammeter still does not indicate "charge" continue to check the following points: (a) Be sure that the belt is not slipping in belt driven models and that the motor and the generator are up to charging speed. (b) Check switch by placing a wire jumper across its terminals; if the ammeter indicates charge that portion of the switch is defective. (c) If the ammeter does not show a charge, check the circuit breaker as follows: Remove the cover from the circuit breaker and examine the contact points. If they are burned, pitted or stuck together, separate them and clean them with fine sandpaper or a breaker-point file. This may be caused by too little tension of the spring connected to the contact arm. Increase the tension by bending the small metal clip, to which one end of the spring is attached. Stuck together points will be evidenced by hot wiring when the generator is not running and the ammeter will indicate "discharge"; if the ammeter needle remains stationary or does not indicate "charge" with clean contacts, the trouble may be caused by too much tension on the contact spring which does not permit the points to close. If the trouble is definitely located in the circuit breaker and the tension can not be properly adjusted, the installation of a new circuit breaker is recommended because faulty adjustment of this unit may cause considerable damage to the generator. (d) If the ammeter shows "discharge" the leads from the generator may not be connected to the proper battery terminals. These must be connected "plus" to "plus" and "minus" to "minus."

The generator field coils are tested in the following manner: Using the ordinary radio set analyzer, test the shunt winding for current flow. To do

this disconnect the "plus" lead from the back of the switch and the "minus" lead from the ground or the voltage regulator if one is used. Second, connect the "minus" lead to one side of the battery, the "plus" lead to one side of the ammeter and with an extra piece of insulated wire connect the ammeter and battery. Connect the voltmeter across the field coil under test. If either the ammeter or voltmeter read backwards, reverse the leads to the meter that is reading reverse. The shunt winding in the average 6 volt generator should pass about 2.5 to 3.0 amperes; a reading decidedly higher than this indicates a shorted field coil; no reading whatever indicates an open coil. Always check with the voltmeter to make sure that exactly 6 volts is being applied to the field terminals; if the battery is lower than this, considerable less field current is to be expected.

The repair and adjustment of the gasoline motor can hardly be considered a part of the radio service man's job and any major repairs should be made by a skilled mechanic who is equipped with the proper tools for the purpose. However, the ignition system should be carefully checked over. A typical circuit is shown in Fig. 4.

Wind Driven Plants

The adjustment and repair of the wind-driven generators is carried out in exactly the same manner as that of the motor-driven types outlined above. Generally, most of the troubles encountered in these plants are due to either a faulty installation, with excessively long leads from the generator to the 6 volt battery, or a lack of wind power. It is usually necessary to remove the propeller assembly and drive the generator with either a small gasoline or electric motor when making repairs and adjustments in the shop.

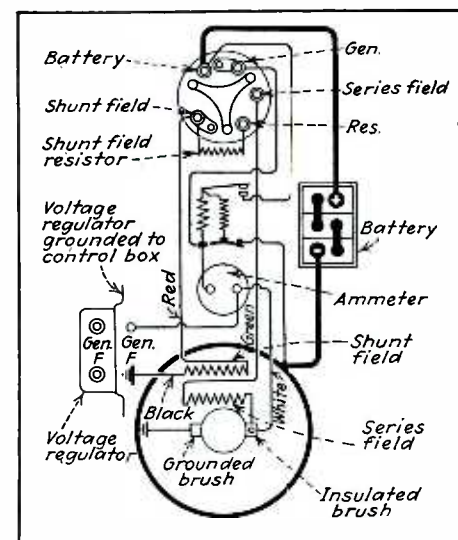
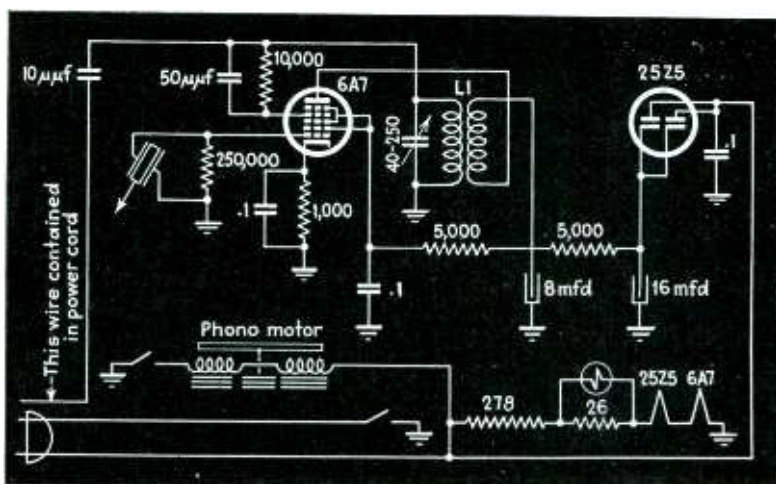

FIG. 4— Ignition circuit of a typical gas charger.



Remote Record Player

A novel arrangement of components in the Wilcox-Gay wireless record player has caused considerable interest.

The schematic of the unit is shown herewith. A crystal type pickup feeds its audio output to the number 1 grid of a 6A7. Grid number 2 has a positive voltage applied to it through a 5000 ohm resistor. This element serves as plate to the input section of the tube.

The remaining elements of the tube are arranged as an oscillator operating in the range from 540 to 740 kc. The coils L1 determine the frequency of oscillation; tuning is accomplished by a 40-250 mmf trimmer. Contained in the line cord is a length of wire which extends from the cord a few inches at the plug end. The other end of the wire is coupled to the grid of the oscillator circuit through a 10 mmf condenser. This condenser and wire serve to radiate energy generated by the oscillator.

Power is supplied from the line through a 25Z5 half wave rectifier to the 6A7. The rectified voltage is capacitive-resistive filtered. The phono motor is shown at the lower left. Separate switches turn on the tubes and phono motor.

When the unit is in operation, oscillation takes place in the upper elements of the 6A7. The energy thus created is radiated by the line cord lead. Thus, the unit is actually a small transmitter and may be received on a nearby receiver. Audio output from the pickup modulates the oscillations electronically. Since the pickup feeds into the lower elements of the tube, the voltage developed on these elements varies the electronic stream in accordance with the audio cycle.

To set up the unit, tune any receiver to 540 kc since this is a clear channel. Then with the unit in operation, carefully adjust the screw driver trimmer until the record being played is heard.

Make this adjustment carefully so that the oscillator is exactly in tune with the set. In the case where the set does not tune to 540 kc, any other clear channel up to 740 kc may be used.

In cases where sufficient signal is not received at the receiver or stormy weather causes undue static, connect an insulated lead from the set antenna post to the free lead on the record player line cord. Do not make positive contact with this line cord wire, merely twist the two insulated leads together.

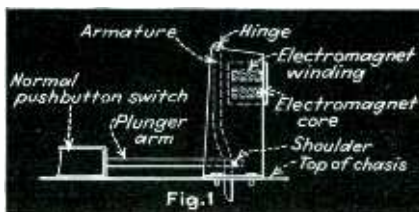

Magnetic Remote Tuning

Another approach to remote tuning is an electromagnetic actuated system by Airline. The construction is quite foolproof in that it is built around a standard trimmer-tuned push-button chassis. There are 6 buttons which are operated in the usual manner on the panel of the receiver.

For remote operation, an assembly consisting of 6 electromagnets and their corresponding armatures mount on the rear of the chassis so as to engage the protruding plunger arm of the switches as shown in Fig. 1. The electromagnets are wired to separate buttons on the remote box. Also in this circuit is a low voltage rectifier which delivers power to the relay

windings. Thus, when any button on the remote box is pressed, a corresponding electromagnet is energized, drawing the armature toward the magnet core and pulling the switch plunger arm. The arm, in turn, closes the switch contacts and the desired station is tuned in.

The action of the switch is similar to a standard push button switch in that any plunger arm remains locked in the "on" position until another button is actuated. Because of this, it is only necessary to momentarily press a button on the remote box. A further advantage is that the receiver may be push-button tuned from the set itself without throwing a "remote-automatic" switch.

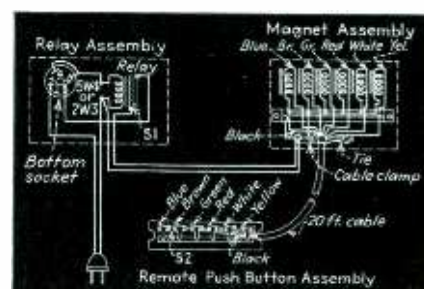

Dual Converter

Two individual non-synchronous vibrator units in a new Radiart vibrator supply permit outputs up to 600 volts at 100 milliamperes. In addition intermediate taps of 225, 300 or 450 volts are available at higher current ratings.

As illustrated in the schematic, the vibrators are separately fused, and as each is operating in its own circuit, failure of one will not cut off the entire unit.

Since the vibrators used are non-synchronous, a tube is used to rectify the a.c. voltage. This may be a 6WG5 or an 0Z4.

A novel attachment to this unit is the separate 110 volt winding on the transformers for use on a.c. when a power line is available. This doubles the use of the supply and makes it particularly handy for emergency and trailer use.

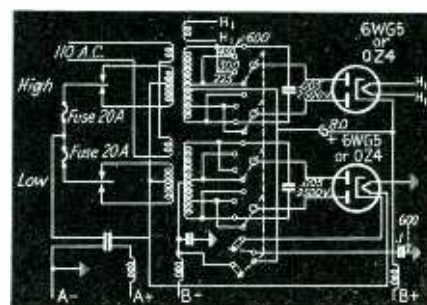

ALL EYES ARE ON....



THE WESTON VACUUM TUBE VOLTMETER

\$50⁶³
NET

TO SERVICEMEN IN U.S.A.
(carrying case extra)

**The most versatile
...most profitable
low-priced instru-
ment for dynamic
or channel testing!**

Here's what you can do with the
WESTON Vacuum Tube Voltmeter:

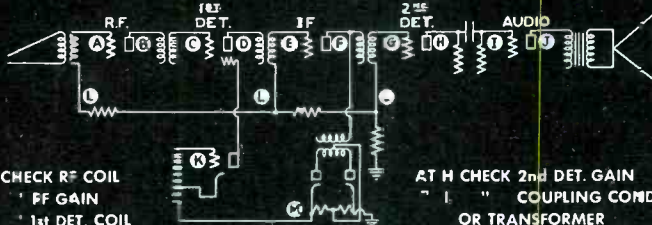

AT A CHECK RF COIL
" B " RF GAIN
" C " 1st DET. COIL
" D " 1st " GAIN
" E " IF TRANSFORMER
" F " IF GAIN
" G " 2nd DET. COIL

AT H CHECK 2nd DET. GAIN
" I " COUPLING CONDENSER
OR TRANSFORMER
" J CHECK AUDIO GAIN
" K " OSCILLATOR VOLTAGE
" L " AVC ACTION
" M " AFC "

Before you buy... be sure to have complete information on this inexpensive *fundamental* servicing tool! Return the coupon today.

Weston Electrical Instrument Corporation
531 Frelinghuysen Ave., Newark, N. J.

Send data on the Vacuum Tube Voltmeter as well as Vol. 2 of the helpful
WESTON Pointer.

Name _____

Address _____

City _____

State _____

PROVED RIGHT THRU THE YEARS!

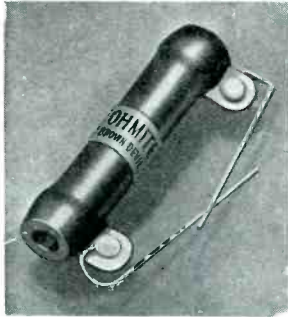

OHMITE BROWN DEVILS

There's good reason for the world-wide popularity of Ohmite "Brown Devil" Resistors. They're tough, extra-sturdy units—built right, sealed tight and permanently protected by Ohmite Vitreous Enamel. Their long, continuous record of trouble-free service in countless installations—

their ability to stand up under shock and vibration, heat and humidity—have proved their complete dependability. That's why Servicemen who want to end resistor failures and eliminate costly "call-backs" ask for "Brown Devils." 10 and 20 watt sizes, in resistances from 1 to 100,000 ohms. Priced right, too!

Ask Your Jobber, or Write Today for Catalog 17.

OHMITE MANUFACTURING CO.
4845 West Flourney Street Chicago, U. S. A.

Be Right with **OHMITE**
RHEOSTATS • RESISTORS • TAP SWITCHES

NO BALLYHOO
NO FANCY
DEALS BUT
**MORE
PROFIT**



THE QUALITY NAME
IN RADIO TUBES

Triad "peaked" tubes not only give you a larger installation profit but they cut down unprofitable call backs.

Pre-tested elements and rigid inspection and intermediate tests make TRIAD a uniformly long life tube that must satisfy! No wonder TRIAD Tubes are initial equipment with over 20 leading set manufacturers.

DEALERS! SERVICEMEN!
Write for our New Profit Making Proposition!

TRIAD THE QUALITY NAME
IN RADIO TUBES
MANUFACTURING CO., INC.
PAWTUCKET, RHODE ISLAND

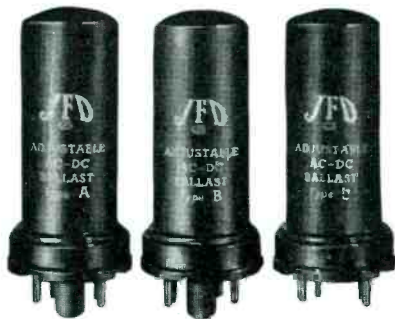

TYPE A
8 PRONG

TYPE B
8 PRONG

TYPE C
4 PRONG

THESE THREE **JFD**

**Adjustable AC-DC Ballasts will serve to replace
99% of the AC-DC Ballasts now in use**

Once adjusted, these ballasts will deliver the exact voltage of the ballasts replaced and will remain accurate permanently—No great stock required as these three tubes will take the place of 99% of the ordinary AC-DC Ballasts usually carried—No large investment necessary and no obsolete merchandise—Simple to adjust... no tools or experience necessary—Complete chart listing over 800 AC-DC Ballasts which may be replaced by J. F. D. Adjustables enclosed with each tube.

Handy dealers' and servicemen's kit No. 770 contains 5 ballasts, 2 Type A—2 Type B—1 Type C complete with replacement chart and simple instructions.

J.F.D. MANUFACTURING COMPANY

4111 Fort Hamilton Parkway

Brooklyn, New York

A COMPLETE LINE—SENSIBLY PRICED!

AC
MODELS

Sentinel

FARM
MODELS

QUALITY RADIO SINCE 1920

Sentinel Radio Corporation • Dept. RR • 2222 Diversey Pkwy., Chicago

Vertical Home Antenna

Probably developed through the popularity of the vertical car antenna a new home antenna has been devised by Philco.

Unlike the usual flat top antenna, the system consists of a 12 foot vertical rod. Attached to one end are two special insulators and metal straps. The straps are so constructed that they may be easily clamped around a roof-top drain vent or any similar protrusion. It is also possible to mount the clamps on the side of a building.

A single feed wire connects the antenna proper to the set and lightning arrestor. The arrestor circuit and coupler is shown. Connection to the set is made through a 2000 mmf. condenser. The purpose of this is to

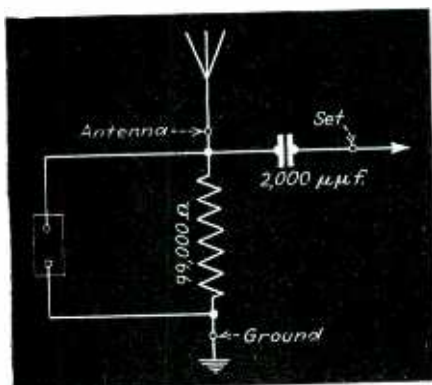

isolate any charge picked up by the antenna from the set, at the same time allow radio frequency energy to pass freely.

A 99,000 ohm resistor connects from the antenna end of the coupling condenser to ground. This serves as a leak for any static charge which might build up on the antenna and lead-in. The value of the resistance is sufficiently high so as not to affect signals picked up by the antenna.

Across the resistor is a gap-type lightning arrestor which operates to discharge the antenna on large static charges.

Overmodulation Indicator

A simple, yet positive indication of modulation percentage has been announced by Acoustic. Adaptable to any type of modulated transmitter, it flashes red when modulation peaks over 100 per cent are reached.

The indicator of a glass tube filled with a combination of inert gases such as argon, helium, and a small part of mercury. There is no neon present.

The inside of the tube is coated with a fluorescent material similar to the screen of a cathode ray tube. The coating on the bottom section, up to the 100 per cent mark, consists of synthetic wilmanite, producing a green glow when subject to positive ion

WHAT THIS BUSINESS NEEDS . . .

By W. M. Hollis

WHAT THIS BUSINESS NEEDS . . .

is filter-chokes and power transformers with windings better insulated from their cores. That's where most of them fail despite good insulation between layers and at the leads. Its usually due to nicking of varnished cardboard core insulation when the laminations are shoved into windings at the factory.

Radio Retailing will pay \$1 for every published "What This Business Needs". Submitted items must be technical and constructive.

bombardment of the ionized gases and ultra violet excitation of the vaporized mercury. The top section of the tube is coated with a special silicate material which fluoresces red.

As to the action of the tube; one end of the tube connects to the r.f. output circuit and the other end to ground so that r.f. is impressed across the tube. Such a tube exhibits the properties of ionizing at the bottom since this is nearest the impressed r.f. voltage; the ionization continuing up the tube, the length of ionization depending on the amount of voltage impressed. This action is similar to the more common long neon tubes.

As the ionization of the gas pro-

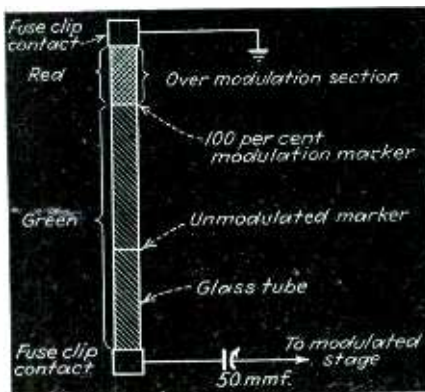

ceeds up the tube in accordance with increases in voltage, so does the fluorescence of the inside coating travel up the tube as explained above. A short distance up the tube is black mark. With the transmitter unmodulated, the coupling condenser shown in the illustration should be adjusted so that fluorescence takes place just up to this mark. Then as the transmitter is modulated the fluorescence will move up the tube in accordance with the percentage of modulation. When 100 per cent modulation is reached the fluorescence will be up to the second black mark. Any further modulation will cause the fluorescence to travel further into the silicate coating area, causing this section to fluoresce red.

PROTECTION

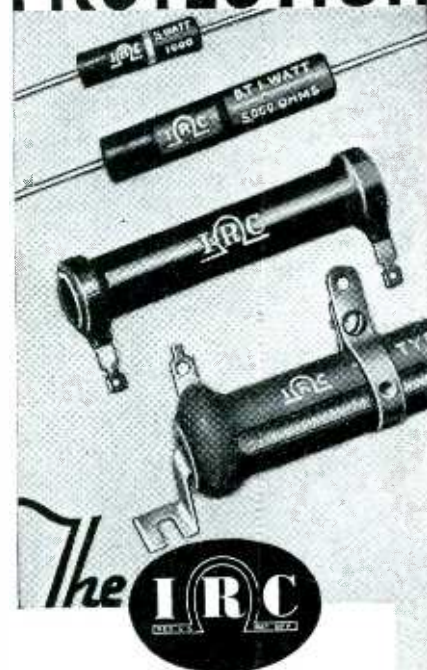

Secret of TROUBLE-FREE RESISTORS

It is a matter of record that nine out of ten resistor breakdowns are caused solely by failure of the protective covering, either in its job of keeping moisture from the element, or in dissipating heat properly.

. . . It is also a matter of record that the outstanding popularity of IRC Resistors results in no small part from their perfection in this respect. Hand in hand with engineering improvements inside of the resistors themselves, IRC has pioneered and perfected BOTH Molded phenolic insulation for IRC BT Metallized Resistors and other types, as well as the famous Cement Coating for heavy duty power wire wounds.

By whatever test you choose to make—even boiling hot and freezing cold salt water immersion—you'll find these IRC protective coatings supreme.

"They Stay Put"

**INTERNATIONAL
RESISTANCE COMPANY**

401 N. Broad St., Philadelphia, Pa.
In Canada, 187 Duchess St., Toronto, Ont.

Every Value and Performance Standard **SMASHED!**

TWO YEAR *Guarantee of Performance and Accuracy on every Instrument*

Here are instruments designed by "Service-Minded" engineers! Just as you would build them if you had a staff of research engineers.

Our organization includes men who have personally talked to over half of the active servicemen in the country—who have worked with virtually every set manufacturer's service department—who have contributed to the most important service instrument developments of the last ten years.

"Expect great things"—from us,

for we have the experience and the desire to serve you well.

Proudly we present our first two instruments. Each represents over eighteen months of careful planning and field testing. Hundreds of service engineers are already enjoying their outstanding performance. We invite your interest and comments.

John S. Meck



A Sensational Dynamic Conductance Tube Tester The Pattern 20 TUBEMASTER



The tube-checker you would design for yourself! Beauty plus brains! Checks every tube including new television base (Loctal) twelve hundred series. Guaranteed for two years against obsolescence.

New DYNAPOWER circuit is far in advance of testers showing only emission, power output or mutual conductance. GOOD-BAD scale readings are dependent upon all three vital performance characteristics. Calibrated scale provides for accurate matching. Simplest operation ever devised. Four straight line settings. Free reference control and two spare sockets defeat obsolescence. The TUBEMASTER "makes push-buttons obsolete!"

The TUBEMASTER brings you the ultimate in sales making eye appeal. Control panel and meter dial are multi-color dialophane, illuminated from below—a striking advertisement of your tube service. Finished in silver grey and black with chrome banding. Giant 10-inch drum dial gives test settings at a glance.

Plus many more features. Write for engineering bulletin today. Net price only.....\$29.50

Save TIME on Repairs — Save MONEY on Parts with the BRIDGEMASTER

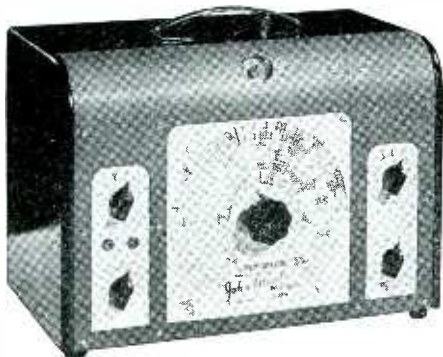

It's far more than a condenser analyzer!

The BRIDGEMASTER fills an important gap in your laboratory equipment. Can you accurately measure 1/2 ohm or 1000 megohms? You need to in modern servicing.

Can you test every condenser under ACTUAL RATED WORKING VOLTAGE? If you can't, don't bother to test them at all! Can you read condenser leakage directly in megohms (up to 1000 megohms), the condenser manufacturer's standard test? Neon bulb guessing won't do. Can you read coil inductance directly in microhenries, 4 to 1000? Condenser capacity and power factor accurately, too?

The BRIDGEMASTER does all this and more. It is backed by a complete manual on condenser test limits. You KNOW when a new or old condenser is safe to use in any circuit.

Net price, complete.....\$29.50

FREE — "How to Compare Condensers"

Send me, at once, a copy of your new manual on condenser testing which includes test limits for all receiver condensers.

Name

Address

My Jobber

JOHN MECK INSTRUMENTS

162-A N. May St., Chicago, U.S.A.
Cable Address—ELDECO, Chicago

Backwave Baffle

A novel baffle system made available by Bi-Phonic Labs utilizes backwave from the speaker cone for increased low frequency output.

The construction of the baffle, as shown, consists of a chamber, reinforced so that cabinet resonance is eliminated. The outer housing consists of one half inch plywood so put together that all joints are airtight. There are, however, three openings. One opening directly in front of the speaker cone permits normal sound

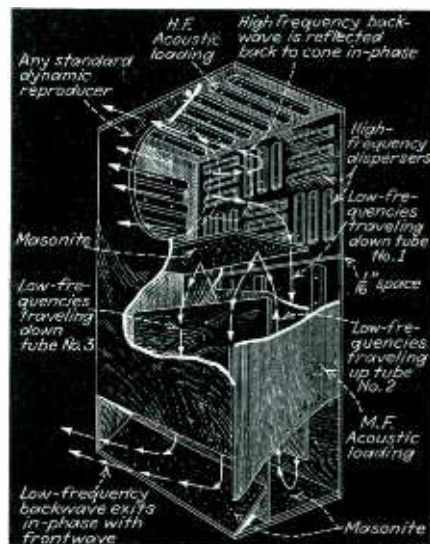

vibrations to radiate from the speaker. A second opening at the bottom front of the cabinet radiated low frequency backwaves created by the back of the speaker cone. A third opening in the center rear of the cabinet acts as a "breather."

Backwaves which would normally cancel frontal waves are radiated from the rear of the speaker cone and pass down a box-like tube shown as tube number 1. They are reflected from the masonite bottom and pass up tube number 2 and are further reflected down tube number 3. At this point they meet an inclined reflecting surface and are reflected out of the cabinet and slightly upwards. The characteristics of the three chambers is such that low frequency waves receive a phase reversal. At the bottom end of tube number 1 the sound waves are in phase with the front wave. The same sequence takes place in tube number 2 and 3. The waves are out of phase at the end of tube number 2 and in phase again at the end of tube number 3. Backwaves are then permitted to radiate from the cabinet.

At the resonant frequency of the tubes any resonating waves are cancelled out within the tubes.

As a result of these functions, the cone is undamped at the high frequencies; at the very low frequencies the cone automatically sets a much larger body of air into motion, giving increased air displacement.

TRIPLETT

NEW 1939 SERIES

Push Button

TUBE TESTER

\$39.00



MODEL 1610

- ★Tests All Receiving Tubes and Has Ballast Tube Continuity Test
- ★Separate Plate Tests on Diodes and Rectifiers
- ★Uses Approved Emission Circuit Constructed to RMA Load Requirements

\$39.00 Net

- ★Neon Short Test
- ★Illuminated Dial or End-Good Scale

Beautiful metal case, black velvet electro finish with chrome fittings. A tester you will be proud to operate and proud to show. This new push-button tester catches the eyes of everyone. Compact in size, light in weight and sturdily built with all wiring in orderly cable form, it can be handled easily and safely. The new black velvet finish case with chrome fittings and the attractive colored buttons create an atmosphere of distinction and ultra modernness whether the tester is used on the country, in the shop or on call in the home.

TRUE DYNAMIC MUTUAL CONDUCTANCE TUBE TESTERS

Many misleading names indicate a Dynamic Mutual Conductance Circuit. . . . Triplet's is a true dynamic mutual conductance tester in every sense of word.

MODEL 1615 Dynamic Mutual Conductance Tube Test shows not only GOOD and BAD on illuminated dial but the percentage of mt. to 100. Diodes and rectifiers are tested for emission according to the latest approved engineering standards. Ballast tube continuity test and gas test included. In same case as 1610. **\$63.34**
Net, Price

MODEL 1616 Same as 1615 but includes push-button Volt-Ohm-Milliammeter readings: E.C. Volts 0-10-50-250-500-1000 at 1000 ohms per volt; D.C. Milliamperes 0-10-50-250; Resistance 2 to 500 ohms-300,000 ohms, 1.5 megohms and 3 megohms; A.C. Volts 0-10-50-250-500-1000 at 400 ohms per volt. Decibel chart permits readings against volts to 42 decibels. Uses plug-in type rectifiers. Net Dealer Price.. **\$76.34**



Model 1615

MODEL 1511 is same as Model 1616 but is in a standard 1500 series quartered-oak case with selector switch controls. Net Dealer **\$59.67**
Price

MODEL 1510 is a Dynamic Mutual Conductance Tube Tester only. Same as Model 1511 less Volt-Ohm-Milliammeter. Net Price **\$49.67**

Model 1510



MODEL 1610

● Model 1610 is Triplet precision built. GOOD-BAD illuminated meter. The approved emission type circuit used is constructed to RMA load requirements and is conclusive. All types of receiving tubes including ballast tubes can be tested, push-button settings for each tube being given under each row of buttons on the scroll at bottom. Line voltage adjustment also controlled by push-buttons. Model 1610. Complete. Net Price. . . . **\$39.00**

MODEL 1611

● Combines push-button Volt-Ohm-Milliammeter with Tube Tester of Model 1610 in same type case. Readings: D.C. Volts 0-10-50-250-500-1000 at 1000 ohms per volt; D.C. Milliamperes 0-1-10-50-250; low ohms shunt type circuit 1/2 to 500; 300,000 ohms, 1.5 and 3 megohms, series type circuit; A.C. Volts 0-10-50-250-500-1000 at 400 ohms per volt. Uses plug-in type copper oxide rectifiers. Model 1611. Dealer **\$49.50**
Net Price

MODEL 1212 TUBE TESTER

● Emission type tube tester circuit as used in Model 1610 but unit has selector switches instead of push-buttons and is installed in popular master case. Net **\$22.00**
Dealer Price

Be Sure to Enter Triplet's \$500.00 Radio Service Puzzler Contest! Get Entry Blank from Your Local Jobber!

The Triplet Electrical Instrument Co.
200 Harmon Dr., Bluffton, Ohio

— Please send me more information on:

- Model 1610 Model 1611 Model 1615
 Model 1616 Model 1510 Model 1511
 Details on Radio Service Puzzler Contest.

Name

Address

City

State

TRICKS

AIRLINE 62-425

Hum, no reception . . . open section in dual 8 mfd. electrolytic condenser in cylindrical container atop chassis. Use common positive type replacement.

APEX 26

No reception, smoke from transformer . . . unit itself perhaps not at fault. Cause is sometimes faulty insulation on wires in cord-bound cable. To check this, remove chassis from cabinet and turn chassis upside down. Switch receiver on and at same time watch cable closely: there will likely be a spark or flash noted at point where wires are shorting.

CROSLEY 95

Poor quality, weak . . . Check polarity of speaker field leads.

CROSLEY 555

Loss of volume . . . leaky condenser No. 14 in schematic connected between anode grid of converter and primary of oscillator coils.

COURIER 65

Oscillation . . . Connect a .1 mfd condenser from the volume control contact opposite the grounded contact.

DELCO 500

No volume . . . Connect a .001 mfd condenser from the lug on top of r.f. section of gang condenser to grid of first detector stage.

DELCO CHEVROLET 985200

Blows fuses . . . look for short from can to ground of 4-12 mfd electrolytic. To remedy: take can out of clamp and insulate with heavy paper and cambric.

EMERSON DS5

Low volume . . . Check plate voltage of 2B7; if low, replace 100,000 ohm plate resistor.

FADA 25

Weak . . . test the bypasses connected across the plate and cathode of the 27 detector. Replace with .001 mfd unit.

GLORITONE

Oscillation . . . shield control grid of tube not covered by shield can, or simply wrap a few turns of wire around lead and ground.



SOUND MEN!

ARE YOU OVERLOOKING C.I.S.E.?

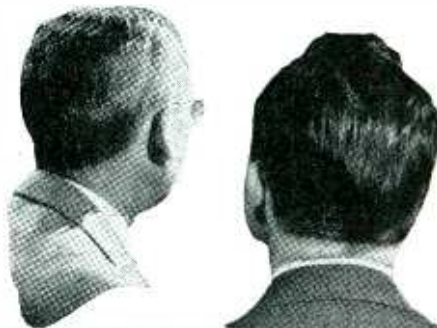

NEW SELLING PLAN HANDS BUSINESS BACK TO YOU

It makes no difference what your title may be—dealer, jobber, sound specialist. If your business is selling sound, then the C.I.S.E. plan is your dish! It was planned, conceived and engineered to give the sound business back to you lock, stock and barrel, enabling you to meet at once all competition—

AND STILL MAKE A PROFIT!

HUNDREDS OF SOUND SPECIALISTS ARE NOW OPERATING PROFITABLY AS C.I.S.E. AGENTS.

See what free membership in C.I.S.E.—the Clarion Institute of Sound Engineers does for you—

1. Gives you factory purchasing power!
2. Gives you exclusive selling territory!
3. Gives you free engineering and consulting service!
4. Gives you competition-smashing prices!
5. Gives you protected profits on the fastest-selling most complete line of P. A. equipment in the world!

Several choice territories—fully protected markets—are still available. Mail this coupon today. It will bring you complete information on the C.I.S.E. "Sound" merchandising plan. This will cost you absolutely nothing. But remember—you must hurry, your territory may be closed tomorrow!

CLARION INSTITUTE OF SOUND ENGINEERS
69 WOOSTER STREET, NEW YORK CITY

CLARION INSTITUTE of SOUND ENGINEERS
69 WOOSTER ST. RR-1038 NEW YORK, N.Y.

Please send me an application form immediately.
I want to belong. This, in no way obligates me,

Name

Address

City State

PASTE COUPON ON PENNY POST CARD

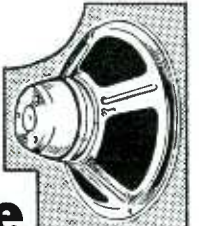

the big reason why
CINAUDAGRAPH is your best
speaker bet!

↓

↓

↓

↓

Precision engineering is the secret of Cinaudagraph's talk-of-the-industry performance. Now, at new competitive prices, the world's outstanding speaker becomes the outstanding speaker "buy"! You pay no more today for the quality, richness of tone and long-life dependability sealed into every Cinaudagraph unit. Investigate the new profit possibilities in this complete speaker line used so extensively by the country's foremost manufacturers of radio and Public Address equipment.

A complete line for both indoor and outdoor applications. Electro-dynamics (5" to 27"), and permanent magnet speakers (5" to 18") now available. Send for new catalog to...

CINAUDAGRAPH CORPORATION

DEPT. 10K SPEAKER DIVISION EXPORT DEPARTMENT
STAMFORD, CONNECTICUT 100 VARICK ST., NEW YORK

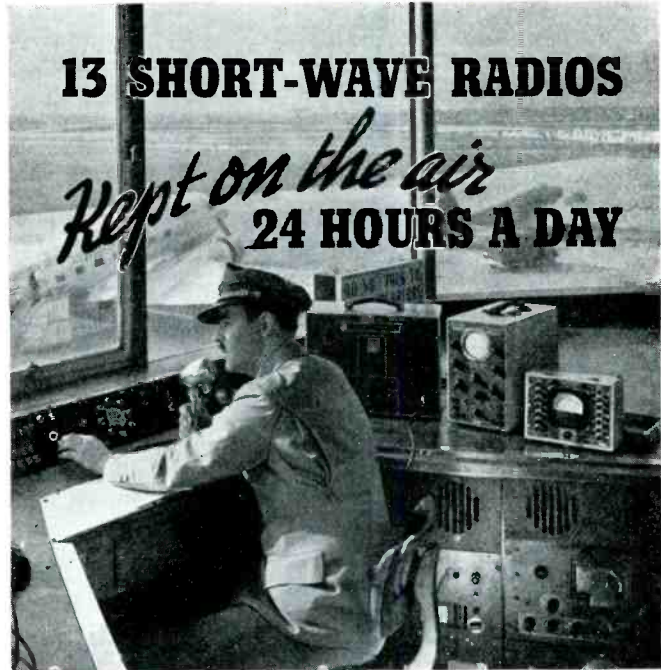
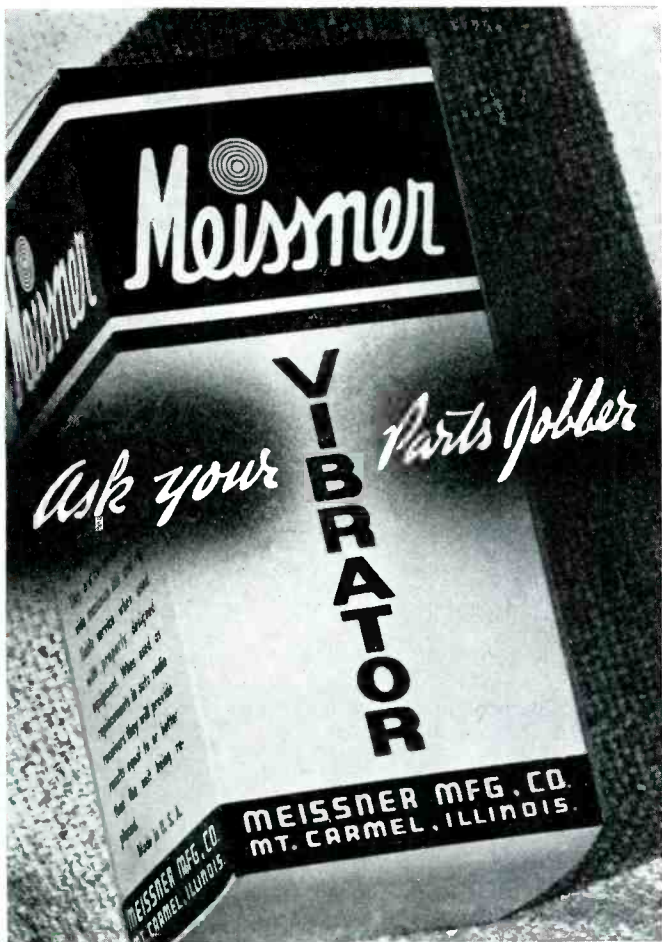

WILLIAM SELLECK
VETERAN DISPATCHER

With
SUPREME
Instruments

Eight major airlines make 100 scheduled takeoffs and landings each day at the "Busiest Airport in the World." The Dispatcher in the Control Tower at the Chicago Municipal Airport must have constant communications on thirteen radio frequencies. All the equipment is the finest, so it is no wonder that years ago SUPREME instruments were selected for the difficult job of keeping those 13 receivers "perking" every hour of every day and night week after week, month after month! SUPREME was selected for the same reasons that *more radios are tested each day with SUPREME instruments than with any other kind!* It is the supreme tribute to **QUALITY!**

The instruments shown ready for instant use are the Model 582A Push-Button Signal Generator, the 546 Oscilloscope, and the lightning-fast 592 Push Button Speed Set-Tester.

Your Parts Jobber sells SUPREME instruments on the lowest terms in radio history!

SUPREME

SUPREME INSTRUMENTS CORP. GREENWOOD MISS., U. S. A.

EXPORT DEPT., ASSOCIATED EXPORTERS CO., 145 W. 45th STREET, NEW YORK, N. Y., CABLE ADDRESS: LOPREN, N. Y.



Just Charge It,

Your work must stand up if you expect to make prompt collections. The sure way is to use dependable Ward Leonard Replacement Parts. They are made right and are conservatively rated. Send for the Servicemen's Data Sheet and Price List.

WARD LEONARD ELECTRIC CO.
35 SOUTH STREET, MOUNT VERNON, N. Y.
Please send me Price List Circular 507-A.

Name
Address
City State.....
Jobber's Name.....

**MAIL
COUPON
TODAY**



SUPREME INSTRUMENTS CORP.
Dept. RR-10, Greenwood, Mississippi

Please RUSH me information on:— Signal Generators;
 Oscilloscopes; SPEED Instruments.

Name
Address
City State



The **AMPERITE**
ACOUSTIC
COMPENSATOR

gives you
HIGH OR LOW PITCH
WITH THE SAME MICROPHONE

With the flip of a finger you can now (1) lower or raise the response of the microphone. . . (2) adjust the microphone for most desirable response for close talking or distant pickup. . . (3) adjust the system to any "taste", room condition, or equipment.

MODELS RBHk, RBMk, with Acoustic Compensator, frequency range 40 to 11000 cps, output, -65 db., complete with switch, cable connector and 25' of cable. . . . \$42.00 LIST

NEW! MODEL RSHk (hi-imp); RBSk (200 ohms) Frequency range 60 to 8000 C.P.S. Output -68db. . . . **Chrome or Gun-metal** \$32.00 LIST

NEW LOW-PRICED CONTACT "MIKE"
\$12.00 LIST



The new popular-priced Amperite Contact Microphone can be used on most radio sets made since 1935 and on all P.A. systems. It "makes an ordinary violin sound like a Strad" . . . gives a small piano the tone of a Grand. And yet, there is no distortion. No unnatural effects. No "fingering noises." No changes in strings or instrument. Attached without tools.

Operates with either high or low gain amplifiers. Has frequency response of 40 to 9000 cps. Output, -40 db. 20' of cable.

MODEL SKH (Hi-imp); SKL (200 ohms), \$12.00 LIST
Professional Model KTH (or KTL). \$22.00 LIST

NEW COMPACT "MIKE"



A new velocity microphone of compact size, having a head only 1 1/4" x 2 3/8" x 1 3/8". Good for speech and music. May be used as hand mike as well as for stand mounting. Complete with output transformer, cable connector and switch. Output, -70 db. into open line. Frequency response 60 to 7500 cycles.

MODEL ACH (Hi-imp.); ACL (200 ohms) \$25.00 LIST

MODEL RAH...\$22.00 LIST

P.A. Men, you can improve those "price" jobs by using the popular Amperite Model RAH (or RAL). You will get better results because (1) it is excellent for both speech and music; (2) has flat response without undesirable peaks; (3) reduces feedback; (4) stands up under rough handling and changes in temperature, pressure or humidity. . . . Frequency range 60 to 7500 cps. Output, -68 db.



MODEL RAH (Hi-imp); with 12' of cable; RAL (200 ohms) with 8' of cable, **ONLY \$22.00 LIST**

Write for Complete Illustrated Bulletins and Valuable Sales Helps.

AMPERITE 561 BROADWAY, N. Y. Cable Address: Alkem, New York

AMPERITE velocity **MICROPHONE**

MONARCH 1000
Dead . . . by observing the 25Z5 tube it will be noticed that one section does not light. This is due to a shorted filter condenser, usually the one ahead of the filter choke. Replace condenser and tube.

MOTOROLA 1938 MODELS
Set blurbles when jarred . . . check i.f. transformer and tube shields for good ground to chassis. A good cure is to solder the shields to the chassis.

PHILCO 19, 89
Intermittent or weak on high frequency end of dial . . . examine the mica between the plates of the high frequency oscillator trimmer. If small cracks are visible in mica, replace with new mica.

PHILCO 70
When replacing the filter condensers be sure to insulate the can from ground, otherwise the 47 tubes will be without bias.

PHILCO 86
Dead . . . Check for a shorted .1 mid condenser sealed in cylindrical can along with the plate resistor. Disconnect the condenser lead and substitute a 600 volt unit.

PHILCO 90
(With one 47 output) Weak, stations do not track with dial settings . . . although the i.f. peak is given as 260 kc. by the manufacturer some were built to align at 175 kc.

PHILCO 111, 111A, 112, 112A, 211, 211A
Weak, distorted, noisy . . . suspect audio transformers for open in these receivers.

Shop Shorts
By G. E. Lingafelter

To eliminate noise on carbon type volume controls try cleaning the element with a soft rubber eraser.

It is usually a good policy to check the power line bypass on all sets. In a number of cases it has been found that replacing this condenser decreases the light bill.

A small 1/2 inch paint brush is very handy to thoroughly clean the chassis, tuning condensers and padders before servicing.

JIM QUAM Says

There's one rule we've always followed around our factory—and, by golly, every one of our people know what will happen if they break it—Quam Speakers have got to be right!

We've got a reputation for quality and the surest way we know to lose it is to let that quality slip. We're trying to make the best speakers that are built, and—if we can build 'em any cheaper by using some smart production trick, why, that's fine, we'll pass our savings along to our customers. But, we won't build 'em cheaper by cheating on quality—that's the quickest way I know of to go out of business, and I want to build Quam Speakers for a long time yet. That's why you can always be sure of Quam quality when you buy a Quam Speaker.

QUAM-NICHOLS CO.
33rd Place & Cottage Grove CHICAGO 1674 Broadway NEW YORK

Cut FREE SERVICE TO THE BONE

Free "Recalls" are where your profits go. Cut them to a minimum by using our complete line of Replacement Transformers. Available in exact duplicate or universal mounting to fit all types of Radio Sets.

PRICED RIGHT!

We are "there" with the right price, and fast, dependable service when you need it most. Don't fail to send for your Free Catalog showing the complete line.

FREED THE REPLACEMENT KING

FREED TRANSFORMER CO.
78 SPRING STREET NEW YORK, N. Y.

SOLAR's rich experience originated "little giant" etched foil ultra-compact electrolytics . . . the overwhelming choice of servicemen seeking MORE for their money. Largest selling and most reliable of its type. Sold by jobbers everywhere.

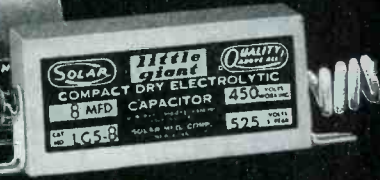

SOLAR MFG. CORP., 599-601 BROADWAY, NEW YORK

Extremely compact. 5 3/4 x 5 3/4 x 2".

Self-contained. Just plug into any outlet.

Handsome black and silver etched panel. Frosted gray case.

Takes UX or octal base units.

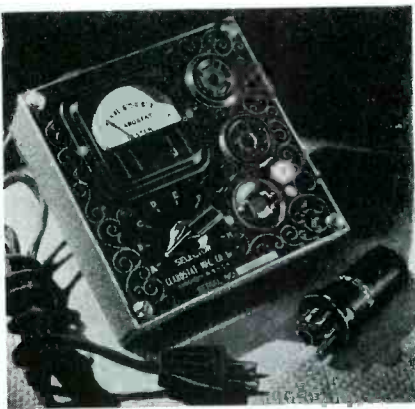

TUBE-TYPE RESISTOR **Tester**

Meter indicates good or bad resistors.

Reference wall chart with each tester.

Only \$7.45 dealer's net cost.

• Servicemen asked for it. So here it is—a convenient, simple, positive means of testing tube-type resistors and line cord resistors for "opens" and other defects. Indispensable. • Write for descriptive folder. • See one at local CLAROSTAT jobber.

CLAROSTAT Manufacturing Co. Inc.

285-287 NORTH SIXTH STREET
BROOKLYN, NEW YORK, U.S.A.

• OFFICES IN PRINCIPAL CITIES •

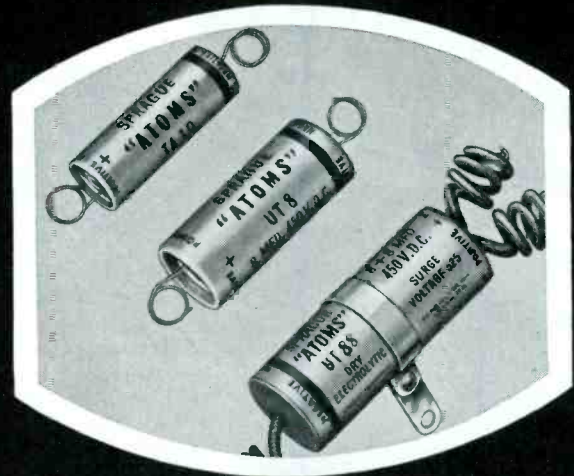

What about those SMALL CONDENSERS ?

TO ALL who have written to ask us "What about those new midget dry electrolytics so many manufacturers are talking about?"—we are glad to make this statement:

Sprague Atoms are beyond question the finest condensers yet produced in small size. We recommend them unreservedly for all ordinary replacements—especially where space is limited or where you need a really reliable condenser at a rock-bottom price. ATOMS will save you time, money and space. They will not let you down.

But do not confuse Sprague ATOMS with ordinary small dry electrolytics. For years, Sprague has led the way toward making better condensers in smaller sizes. ATOMS represent the ultimate of all that Sprague leadership in this direction represents.

ATOMS are made by an exclusive etched foil process, pioneered and perfected by Sprague. "Blowouts" are positively prevented by a Sprague design feature that other manufacturers are only just now beginning to copy. Extremely low leakage avoids overheating. Quick build-up and high surge voltage make them practically fool-proof. They are made in both singles and dual combinations covering every replacement need. They are, in brief, truly universal—a modern Sprague development that every wide-awake radio man ought to know about—and use regularly.



SPRAGUE

GOOD CONDENSERS—EXPERTLY ENGINEERED—
COMPETENTLY PRODUCED

SPRAGUE PRODUCTS CO., NORTH ADAMS, MASS.

**QUALITY TESTERS
at LOWEST PRICES**



Positively Checks Receiving Tubes According to Latest Recommendations of Tube Engineers.

**NEW
MODEL 432
TUBE TESTER Only \$21.60**

- Separate Plate Tests on Diodes and Rectifiers
- Neon Short and Leakage Tests
- Ballast Tube Continuity Test
- Uses Attractive Complete in attractive, sturdy quartered-oak case; suitable for counter or portable use. Sloping etched panel of silver and black.
- Triplet Direct Reading Instrument 3" size. (GOOD-BAD) Scale
- Line Voltage Adjustment
- New Improved Low Loss Switch

MODEL 431 \$15.90
Checks all receiving tubes. (No ballast test.) Tester uses dependable Readrite Meter. Quartered-oak case same as for Model 432.

A.C. and D.C. VOLT-OHM-MILLIAMMETER

**MODEL 736
ONLY
\$12.00**



POCKET SIZE

Sturdy molded case with rounded corners, accessories included.

READRITE METER WORKS
1020 College Avenue, Bluffton, Ohio

Please send me more information on
 Model 432; Model 736; Send Catalog

Name

Address

City..... State.....

MAJESTIC 300 SERIES

Dead . . . test for short in 0.25 mfd. condenser, by-passing screen of G-58-S in r.f. stage. Unit is component of by-pass container with lug terminals. Also check center winding of resonance reactor for open.

Signals fade out completely after short periods of operation . . . 1/2-meg. resistor, connected between cathode and suppressor of G-57-S in first a.f. stage, is likely defective. If short placed across terminals restores operation, replace resistor.

Tuning light inoperative . . . look for short in low voltage, 20 mfd. electrolytic condenser shunted across center winding of resonance reactor. Also note voltage rating of tuning light bulb in use. It should be 2.5-volt type. A 6-volt lamp will light but will not dim on resonance.

MAJESTIC 650

Noisy, crackling . . . this can usually be traced to poor connections in the second i.f. transformer. A high resistance meter connected across the primary with the receiver operating will show fluctuations. Replace transformer.

RCA 9K2

Noise in audio amplifier . . . reheat all connections on 6F5 socket, especially cathode to ground junction.



**NEW CATALOG #161
JUST OFF THE PRESS**

May we send you a copy?

**CORNELL - DUBILIER
ELECTRIC CORPORATION**
1019 Hamilton Blvd.,
So. Plainfield, N. J.
Cable Address: 'CORDU'

**'BULLET'
ELECTRO-DYNAMIC
MICROPHONE**

IMPROVED MODEL MK-31

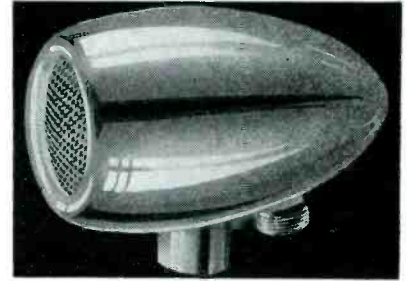

THIS new, improved mike is the "last word" in dynamic types, noted for their faithful reproduction. No barrel effect plus freedom from feedback make it ideal for P.A. work. Frequency response. Flat between 30 and 10,000 cycles; down only—55 db., furnished in either 200 or 50,000 ohms impedance. Finished in chromium and equipped with 25 feet of shielded cable. Designed by the Transducer Corp.

List Price \$27.50

Send for Free Illustrated Catalog describing our entire line as well as trade discounts, etc.

TILTON ELECTRIC CORP.
15 East 26th Street, Dept. RR-11
New York, N. Y.

Ex-Stat Products Bullet Microphone

NEW CATALOG ON REQUEST

Now . . . Get **REAL RESULTS** with
New 1939

**BRACH
Antennas**

*Scientifically Designed
to Insure—*

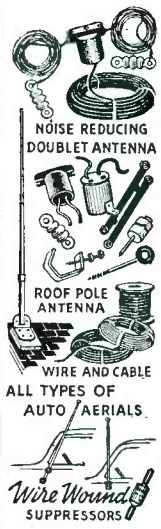

- ✓ BETTER RECEPTION
- ✓ EASY INSTALLATION
- ✓ PERMANENCE
- ✓ SATISFIED CUSTOMERS
- ✓ GOOD PROFITS
- ✓ MORE SALES

The BRACH line is a complete line and every item is priced right. Large stocks on hand at all times insure prompt deliveries. Send for new catalog today!

World's Largest Makers of Antenna Systems

L. S. BRACH Mfg. Corp.
55-67 Dickerson Street
Newark, N. J. Established 1906

SPARTON 537, 577

High noise level at all settings of volume control . . . check i.f. transformers, particularly the primaries, for high resistance opens. Test by both voltage and continuity methods as sometimes one procedure will show the coil as being okeh whereas the other will disclose the trouble.

Oscillation with volume control adjusted to about mid-point . . . push control grid of 6Q7G away from 6F6G output tube. Speaker cable wires should also be removed from vicinity of both tubes. (i.f. 456 kc.)

SUPERHETS

To test for images, stop the oscillator by placing a finger on the grid cap of the oscillation tube. If any signal is still present the selectivity of the preselector should be improved. If realigning still does not remove the signal, a wave trap tuned to the interfering signal is necessary.

STEWART WARNER 1251 TO 1259

No reception . . . cause is often 0.006 mfd., 600 volt tubular condenser, connected between plate of 41 tube and chassis. Part No. 83,706. Use 1,000 volt replacement.

Noise . . . lug on 0.02 mfd., 1,000 volt, metal-cased condenser, connected between line and chassis, is often

**"NEW!"
WARD'S DE LUXE
HOME AERIAL MAST**

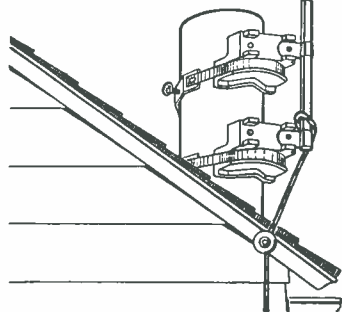

- Can be sold to replacement market as well as with new sets
- Provides better reception, better pickup than old style "clothes-line" aerials
- Made of attractive, rustproof, nickel-plated bronze tubing; 4 sectional; 12 ft. high
- Easy to mount to soil pipe, or against chimney, window frame, garage, etc.

FREE! Write today for free catalog of WARD'S complete line of aerials for car and home.

The WARD PRODUCTS Corp.
WARD BUILDING CLEVELAND, OHIO

pulled loose by line cord. Replace condenser and adjust knot in cord to prevent pull on new unit.

Noise accompanied by sudden volume changes . . . rotor wipers on band-changing switch have lost their extension and making poor contact with stator points.

Hum . . . this trouble also caused by open in line filter condenser.

ZENITH 5714

Automatic tuning dead or noisy . . . dirt on contacts or warped contact strip shorting to ground; also, look for shorted compensating condenser.



recommends

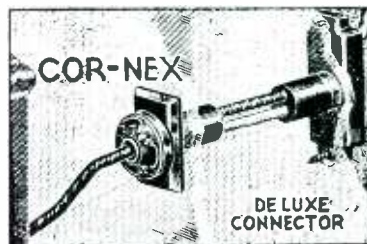

• The above illustration shows both the inside and the outside view of CORNEX, installed on the job and ready to function—a superb invention by a practical service man, which eliminates for all time the sloppy, dangerous connections housewives have for too long put up with. You make a real profit on this one! And how your customers will thank you! Easy to install. Hailed by service men as the greatest innovation in years.

COMPLETE—with DOUBLET lightning arrester, decorative inside plate with leads and polarized plug with cords. . . . List. **\$2.50**



A masterly A.A.&K. licensed system that abolishes man-made static on broadcast as well as shortwave bands. Improves reception in ANY location. Gives your set a CHANCE! Several units at attractive prices.

Distributed through Jobbers

CORNISH WIRE CO., Inc.
30 Church St., New York City



**Increase sales on all lines —
by featuring RCP instruments**

You can't beat RCP testers for sales builders! Stock the "Dependable" line and watch customers flock to your store. They'll buy not only RCP, but other merchandise. And that's the part about the RCP line you'll like—it's a store-leader, a money-maker.

R.C.P.'s franchise distribution plan is protecting R.C.P. jobbers and helping them to new highs in sales. Several territories still available. Your inquiry is invited.

Model 307P Dynoptimum Tube Tester—a combination portable and counter tester—checks all tubes, both new and old types. Tests for shorts and leakage between individual elements. Will also test hot cathode leakage. Uses 3" meter with "good-bad" multi-colored scale. Accurate line voltage indicator on meter.



Model 307P
Complete **\$18.95**
Also Available In
Counter Type
Only **\$16.95**

MODEL 432 TROUBLE SHOOTER

Lowest priced "legitimate" tester on the market today. Yet quality has not been sacrificed to achieve its amazing economy. Pocket size weighing just 24 oz. Its multi-scale E'Arsonval meter accurate within 2%. Has individual low ohm scale. D.C. volts—0-5/0-50/0-500/0-1,000. D.C. ma. 0-1/0-10. Ohms 0-500/0-50,000/0-500,000.



Model
432
Complete
\$5.95

Other tube testers described in detail in new catalog. Send for your copy today.

RADIO CITY Products Co.
88 PARK PLACE NEW YORK CITY

A NEW STAR
ON THE SOUND HORIZON

Atlas "Marine Midget" P. M. Reproducer Unit

Atlas Sound proudly presents to the P.A. trade its newest development, the "Marine Midget" P.M. Reproducer and "Talk-Back" Unit. The reflex design and 15" air column length of the horn insures excellent reproduction of music and speech. The new "Marine Midget" includes all the exclusive weatherproof features of the more expensive Atlas "Marine Horns," plus the identical mechanical protection for the speaker unit.

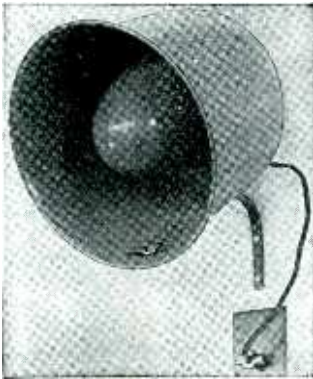

The "Marine Midget" comes completely equipped with P. M. reproducer unit and mounting bracket. It's easy, convenient to install.
MODEL WX-SSP "MARINE MIDGET" LIST PRICE..... \$11.50
Send for technical bulletin on the new "Marine Midget" and a copy of our new Fall P. A. catalog which contains 101 helpful accessories for the sound man. Mike Stands, Baffles, Trumpets, Units, Speaker Enclosures.

ATLAS SOUND CORPORATION
1452 39th Street Brooklyn, N. Y.

DON'T LET SERVICE WORK GET YOUR GOAT!

Equip yourself to MASTER THE JOB—

EVERY service man who is on his toes and who expects to make anything out of service work, needs the backing of Simpson testing equipment. Here are instruments that take all guesswork out of the most complex service jobs. You ought to have the latest information on the many new Simpson developments that are making such a tremendous hit among service men everywhere. We shall be glad to send you the latest Simpson bulletins. Why not write for them?

Simpson Electric Co., 5204 Kinzie St., Chicago

—And now the New 333

Tube Tester—a smaller tube tester built to highest standards of Simpson quality, with a lot of new features, at the remarkably low price of \$26.50. Write for new circular on this amazing little tube tester.



—and the new super all-service, tube and set tester

—the Model 440 "Test-master" There is truly nothing that you can ask for or find in any instrument that is not covered in the Model 440. No other tester selling at any price provides as many tests and ranges! At \$59.00 service men say it's the best buy on the market.



—the smallest "Pocket Type" A. C. and D. C. service Volt-Ohm Milliammeter on the market—the Model 230

At \$14.25 this is an instrument that every service man will want in his kit.



ASK YOUR JOBBER SIMPSON
Instruments that STAY accurate

RECORDS FOR SOUND

(Continued from page 65)

Boos and Hisses
Bugle Calls
Thunder Storm
Wind
Barnyard Noises
Elevated Trains
Model T Ford
Auto Effects
Foghorns

Helpful

Angry Mob
Baby Cries
Church Bells
Breaking China Ware
Coyotes and Wolves
Cheering
Manufacturing Noises
Freight Train
Rainfall and Thunder

These are general sound effects records and several can be used in conjunction with almost any play performance. There are also several recorded background sound effects for the following purposes:

Sad Situation
Approaching Danger
Joyous Scenes
Love Scenes
Quarrels
Patriotic Parade

A few of the sound effect companies which have large libraries and cater to broadcasters and soundmen, are:

RCA-Victor Manufacturing Co., Camden, New Jersey.
Standard Radio, Inc., 6404 Hollywood Blvd., Hollywood, California. Also at 180 North Michigan Avenue, Chicago.
The Starr Piano Company, Richmond, Indiana. Also Starr Piano Company, 1344 South Flower Street, Los Angeles, California and Starr Piano Company, Room 1711, 729 Seventh Avenue, New York City.
Thomas J. Valentino, 729 Seventh Avenue, New York City.

While these companies manufacture effects of various types, several make exclusive effects which no others make. Their catalogs give a complete listing of all effects, the time duration of each, and the cost.

All effects are recorded from actual life sounds and are not synthetic or make believe sounds. Incidentally, these records which are specially pressed on low surface-noise material do not require additional permission or royalty payments for public performance.

The effects vary from one to seven on each side of the record and have separations between each so that they can be picked out with ease and speed.

With such a sound effect library, the sound dealer is in a position at times to rent out his effects, where an amplification system would not be necessary.

Tips on Winter Plays

Speakers for special sound effect interludes should be concealed behind "props" in the event ampli-

(Please turn to page 84)

PRESTO announces
THE NEW ORANGE SEAL DISC FOR HOME RECORDING



HERE is a home recording blank that will make real money for you. The net price to dealers is lower than that of any Presto disc sold in the past. The Presto policy of dealer protection and price maintenance will assure you of a profitable disc business.

The Orange Seal disc is packed ten of a size in an attractive three colored carton that makes an excellent window and counter display.

The Orange Seal disc is easier for the layman to use. Makes a quieter record. Gives longer playing life. Does not harden with age. You can safely stock a six months supply.

Thousands of Presto owners all over the country are buying discs regularly. Be prepared to get this business in your community. Clip the attached coupon today.

PRESTO RECORDING CORP.
135 W. 19 St., N. Y. C.

PRESTO RECORDING CORP.
135 West 19th St., New York, N. Y.

Enclosed is money order check for \$1.65.

Send us a sample order of Orange Seal discs and display cartons .

Name.....

Address.....

City..... State.....

ADVERTISERS INDEX

	Page		Page
Alliance Manufacturing Co.....	65	Ken-Rad Corp.....	62
American Microphone Co.....	64	Mallory & Co., Inc., P. R.....	Inside Front Cover
Amperite Co.....	78	Meck & Co., John.....	74
Arcturus Radio Tube Co.....	47	Meissner Mfg. Co.....	5, 77
Atlas Sound Co.....	82	National Union Radio Corp.....	63
Bell Sound Systems, Inc.....	62	Noblitt-Sparks Industries, Inc.....	7
Bernard, H. J.....	63	Ohmite Manufacturing Co.....	72
Brach & Co., L. S.....	68	Operadio Manufacturing Co.....	59
Burgess Battery Co.....	41	Philco Radio & Television Corp.....	8
Cinaudagraph Corp.....	76	Pioneer Gen-E-Motor Corp.....	64
Clarostat Mfg. Co.....	79	Premax Products.....	66
Continental Radio & Television Corp.....	50, 51	Presto Recording Co.....	82
Cornell-Dubilier Elec. Corp.....	80	Quam-Nichols Co.....	78
Cornish Wire Co.....	81	Radio City Products, Inc.....	81
Crosley Radio Corp.....	Inside Back Cover	Radio Corporation of America.....	44, 45
Emerson Radio & Phonograph Corp.....	49	Ralston Record Co.....	61
Freed Transformer Co.....	78	Raytheon Production Corp.....	3
Galvin Manufacturing Co.....	21	RCA Manufacturing Co., Commercial Sound.....	64
General Electric Co.....	Back Cover, 14	RCA Manufacturing Co., Set Division.....	12, 13
General Industries Corp.....	62, 64	RCA Manufacturing Co., Tube Division.....	10
Hickok Electrical Instrument Co.....	65	RCA Manufacturing Co., Test Equipment.....	55
Howard Radio Co.....	4	Readrite Meter Works.....	83
Hygrade-Sylvania Corp.....	24	Regal Amplifier Corp.....	68
International Radio Corp.....	49	Sentinel Radio Corp.....	72
International Research Corp.....	55	Service Instruments, Inc.....	66
International Resistance Corp.....	73	Simpson Electric Co.....	82
Janette Manufacturing Co.....	62	Solar Manufacturing Co.....	79
J. F. D. Manufacturing Co.....	72	Sprague Products Co.....	79
		Standard Transformer Corp.....	47
		Stromberg Carlson Tele. Mfg. Co.....	2
		Supreme Instruments Co.....	77
		Tilton Electric Co.....	80
		Transformer Corp. of America.....	80
		Triad Manufacturing Co.....	72
		Triplett Electrical Instrument Co.....	75
		Tung-Sol Radio Tubes, Inc.....	55
		Universal Microphone Co.....	62
		Utah Radio Products Co.....	6
		Ward Leonard Electric Co.....	77
		Ward Products Co.....	81
		Weston Electrical Instrument Corp.....	71

SEARCHLIGHT SECTION (Classified Advertising)

	Page
CATALOGS.....	83
EMPLOYMENT.....	83
RADIO STOCKS.....	
Burstein-Applebee Co.....	83
Electro-Voice Mfg. Co., Inc.....	83
Midwest Appliance Parts Co.....	83
New York Radio Supply Co.....	83
Radolek Co.....	83

SEARCHLIGHT SECTION

"SEARCHLIGHT" ADVERTISING RATES

UNDISPLAYED RATE:
15 cents a word, minimum charge \$3.00.
Positions Wanted (full or part-time salaried employment only). 1/2 the above rates, payable in advance.
Proposals, 50 cents a line an insertion.

DISPLAYED—RATE PER INCH:
1 inch.....\$8.00
2 to 3 inches.....7.80 an inch
4 to 7 inches.....7.60 an inch
Rates for large spaces, or yearly rates, on request.
An advertising inch is measured vertically on one column, 3 columns—30 inches—to a page.

EVERYTHING IN RADIO!

Our immense stock of radio sets, parts and supplies enable you to purchase your entire needs on one order. You will find all your Most Usually Known Favorites in the big book which is FREE for the asking. Practically every order is shipped the same day it is received. Write for Catalog

BURSTEIN-APPLEBEE CO.
1012-14 McGee St. • Kansas City, Mo.

OVER 10,000 PARTS
FOR VACUUM CLEANERS AND
WASHING MACHINES

24-HOUR SERVICE!
Attach this "Ad" to Your Inquiry and Receive
"Special Inventory Reduction Price Sheet"
Manufacturers' Factory Representatives
MIDWEST APPLIANCE PARTS CO.
2722 W. Division St. CHICAGO, ILL.

FREE TUBES !!

One Free for every 25 tubes ordered

2A7	\$.15	6B7	\$.25	6AG8	\$.30
55	.15	80	.25	6C5G	.30
71A	.20	1V	.25	6J5G	.30
6A7	.25	75	.25	50	.50

All Guaranteed. Send this ad, with your order
NEW YORK RADIO SUPPLY CO.
152 W. 42 St., N. Y. C.

MICROPHONE REPAIRS

CARBON—VELOCITY—DYNAMIC
ALL MAKES—ANY CONDITION
Write for Quotations

ELECTRO-VOICE MFG. CO., INC.

328 E. COLFAX AVE.
SOUTH BEND, INDIANA

STOP!

Here is the Most Complete
Radio BUYING GUIDE!

The new 1939 Radolek Radio Profit Guide contains complete showings of Radio Repair Parts, Radio Receivers, Public Address Amplifiers, Speakers, Microphones, Service Test Instruments, Radio Technical Books, Special Radio Tools. Leading Standard Brands! Everything you will ever need in the Radio Business all at Lowest Prices. You save money at Radolek!

- Every item you get from Radolek is guaranteed. It must be right or we make it right. Standard merchandise produced by leading Manufacturers with Radolek's guarantee added!
- Everything in Radio promptly when you want it—and exactly what you want. Radolek's efficient organization backed by a huge stock of standard guaranteed quality merchandise insures you the fastest service in the Radio business. Twenty-five Thousand Service-men customers depend on Radolek service and benefit by Radolek's LOWEST PRICES. Send Now for your copy of the Radolek Radio Profit Guide. It will help you make more money.

Send for Your FREE Copy Now!

RADOLEK

601 W. Randolph St., Dept. A-24, CHICAGO

Name.....

Address.....

Serviceman?
 Dealer?
 Experimenter?

Audio Frequency...

Liked Bluebook

I want to congratulate the person or persons who compiled the "Radio Trade-In Allowance Blue Book" as a suggestion of how much to allow customers on their sets when buying new ones. I have never seen anything like this before in any publication and I am sure it will be an invaluable aid to a great many set dealers.

KAUKAUNA, WISC. ROLAND L. KUCK

Puts Oden Story to Work

We thought it might interest you to hear what happened when an organization lifted an idea or plan lock, stock and barrel from your publication and applied it.

Your July issue contained an article: "How to Pick Outside Salesmen". Mr. Rogers made a note at the top of the page and said: "Holly, why not try the \$2 plan on ten men?"

The ad was placed and we were swamped with applicants. It might be said in passing that previous to that time we had run ad after ad without any success whatsoever, but your idea turned the trick.

We selected ten men whom we thought were the class of the applicants and put them to work selling Kelvinators, Chambers Ranges, Washers, Ironers and Radios. That was on August 2nd.

Up to this date these men have sold and we have delivered a total of ninety-nine units of merchandise, most of which, of course, were refrigerators.

We are giving you this information because it seems to us that it is an outstanding job under the circumstances. With one or two exceptions none of the men had had previous sales experience. We sell almost exclusively on the Meter Plan so we did not devote a great deal of time to training but simply drilled them in the Meter Plan approach and presentation, and took them out in the territory properly supervised. The above business resulted.

WHEELING, W. VA. H. HOLLOBAUGH
Earle Rogers Company

Extra From Ephraim, E.E.

Regarding the many questions concerning the relays used in the equipment described in my September issue article entitled: "Two Radio Controlled Displays":

1. Relays used "to the appliances" in my case were Ward-Leonard type, series 81, 110-V, 60-cy., SPDT, normally open.
2. Transfer relay, same as above except DPDT type, normally closed side connected in series with the d.c. source supplying A, B and C relays.

3. Time delay relay, Ward-Leonard type, series 362, supplied with DPDT controlled relay, contacts normally open when wired in circuit diagram.
4. Relay A, American Automatic Electric Company, series AQA, quick-acting d.c., spring assembly Form A (make), catalog No. RA-21, coil resistance 6500 ohms, min. oper. amp. is .0023 milliamperes, max. oper. volts 228, nom. oper. volts 32 (this relay is used in the output plate circuit of the receiver).
5. Relays B and D, same make as relay A, series AQA, spring assembly Form A (make) for the B relay; for the D relay use Form B (break), catalog No. RA-14, coil res. 300 ohms, min. oper. amp. .013 milliamperes, max. oper. volts 49.
6. Relays C and E, same make as A, series ASR, spring assembly for C relay use Form B (break); for D relay use Form A (make). Coil specifications same as for relays B and D.
7. Multi-contact rotary selector switch is American Automatic in my case. Series "minor switch", ten circuit paths, two levels; home position—wipers off bank; off-normal springs Form 1A; catalog No. RA-76, 48-volt coils, rotary magnet resistance 132 ohms, release magnet resistance 211 ohms. Two levels of contacts are used in the switch (one would do) for an additional safety factor. The banks are wired in parallel.

The direct current source can be made up of either a dry-disc or tube rectifier. The d.c. output should have a rating of .250 amperes at 50 volts; momentary overload of .400 amperes. No filters are required.

The dial on the transmitter may be of any reputable manufacture. Contact arrangement is as follows: A contact spring must close on fingering the dial from normal resting position. The closing of this circuit lights the filament of the tube in the transmitter. The circuit remains closed as long as the dial is in operation; this circuit is NOT pulsed. When the dial comes to rest, normal position, the springs must open, thereby disconnecting the battery from the tube filament. In this manner, the tube is only lighted during dialing. The impulse springs must CLOSE only on the return motion of the dial; the springs must normally remain open. The springs open and close the plate supply to the transmitter. The dial governor must be set to the slowest possible speed by adjusting the position of the governor.

The recommended noise rejector system is similar or identical to that developed by J. J. Lamb, in QST; a simple arrangement is also shown in the 1937-38 "Radio" handbook. The detector has delayed AVC imposed upon the preceding IF circuit.

Should there be any other required information it will be a pleasure to cooperate with readers through *Radio Retailing*.
BERNARD EPHRAIM, E.E.
RETRESA, CALIF.

One Cheer To Order

Radio Retailing is certainly worth a dollar but it would be worth even more if you would blast some of the manufacturers and distributors where and when they need it.

For example: The high-handed practice of forcing a dealer to buy antennas with radios at \$3 when he don't want them. Or the stunt of insisting he pay

postage both ways on returned defective parts.

I could name many others. Why not cheer for the dealer, the guy who has to sell 'em, handle the trades, give the service, worry over the bum accounts and repossessions and a few other things.

L. VAN SLYCK

RECORDS FOR SOUND

(Continued from page 82)

fication of the actor's voices is not needed. This method creates an illusion for the audience, who do not see any speakers at any time.

When additional sound amplification is required, it is sometimes better to employ separate amplifiers, one to be of low power output for sound effects and the other picking up the sounds from the stage microphones. This will further increase the illusion of realism, also, any possible scratch noise will be lost by the time it reaches the stage microphones which would not be the case in the event the record was played directly through the main power amplifier.

As several different effects are recorded on each record, it is desirable to incorporate two pickups on a single turntable. This is a simple matter to arrange and the required mixing can be done through most 1938 and 1939 amplifiers that have provisions for two pickups. With two pickups it is also practical to continue an effect indefinitely by playing back and forth.

Care should be taken when installing that two identical pickups be used to avoid differences in reproduction. The tip of the needle should be based in any case on the center record shaft. Care should be exercised so that the two pickups cannot tangle with each other.

In some dramatic presentations action calls for the use of a radio. Such a set may be used and recorded dance music played through the speaker and announcements called for in the scrip made by simply removing the original set speaker and incorporating a speaker hooked to the amplifiers. A small battery can be used to power the pilot lights on the set to carry out the illusion.

THE
1939
CROSLLEY
Sensations

**RADIO
PHONOGRAPHS**



PORTABLE COMBINATION

A highly efficient and simple Crosley developed self-starting record playing mechanism in combination with a new Crosley push button radio. A wooden cover with handle covers turntable pick-up and radio panel. A switch changes from radio to phonograph. Efficient pick-up with volume control provides unusual performance in record playing.

24⁹⁵

CONSOLE COMBINATION

A full size console, the quality of performance — record pick up—radio amplification and speaker reproduction — delights all hearers. It's a wonderful value and it gives a wonderful performance. A flip of a switch plays either radio or phonograph.

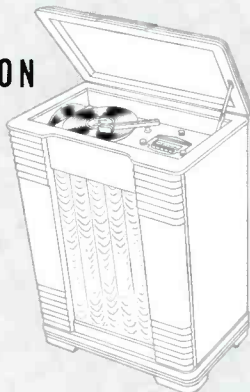

49⁹⁵

New Crosley push button radio incorporated in this model makes this combination a wonderful value and gives every indication of its being top seller in its field.

**NOW MORE THAN EVER
YOU'RE THERE WITH A**

**"THESE ARE PART OF
THE GREATEST LINE IN
CROSLLEY'S 17 YEAR
RADIO HISTORY"**

Powel Crosley Jr.



Factory production facilities taxed. Amazing reports of sales that sound like the radio days of the 20's—enthusiasm from coast to coast—that's the Crosley radio picture NOW. Ride these winners to a profitable radio season.

**6 TUBE 2 BAND PUSH BUTTON
SUPERHETERODYNE** **\$19⁹⁹**

Refinements and improvements added to an efficient radio of which over half a million have been built, plus an extra tube, produces a starting value in this new 1939 "Sixer". Plastic cabinet—easily adjusted push button tuning—as well as manual tuning.



AMAZING PUSH BUTTON RADIO

\$9⁹⁹

Incorporating the new Crosley Push Button tuning technique—positive, sharp—easily adjusted on the button for any station. An amazing value.



Prices slightly higher in South and West.

7 TUBE SUPERHETERODYNE
2 BAND (American and Foreign) PUSH BUTTON

CONSOLE
\$49⁹⁵

A 2 band (American and foreign) 5 push button receiver with electric eye tuning—a radio log dial (99 stations located). Laydown (pictured) and upright table models. Exquisitely fashioned console.

TABLE MODEL

\$29⁹⁵



CROSLLEY

THE CROSLLEY RADIO CORP., CINCINNATI • POWEL CROSLLEY, Jr., Pres. • Home of "the Nation's Station"—WLW—70 on your dial

Engineered FOR PERFORMANCE!
Styled FOR LEADERSHIP!
Priced FOR ACTION!



MODEL G-76

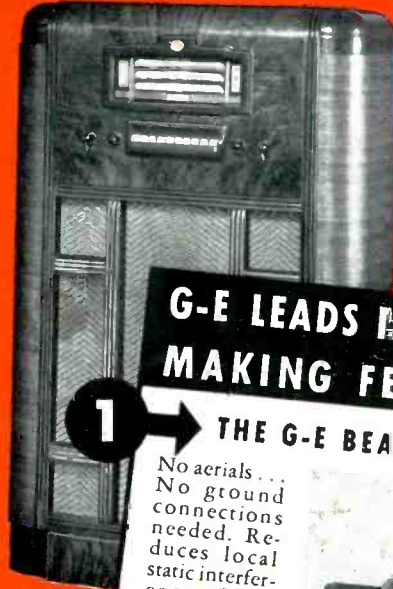

MODEL G-99

**Introducing Two Great New G-E Radios
 for the Biggest Selling Season of the Year**

The two new G-E Radio models presented here will help you cash in on extra Fall, Winter and Christmas business. They bring the amazing G-E features... the exclusive built-in Beam-a-scope and Keyboard Touch Tuning... into new big-volume price brackets... These and all other G-E Radio models are sensational in features, styling and prices. They carry discounts that spell big-profit opportunity. They are backed by a tremendous barrage of General Electric 4-color advertising in ten leading magazines... in pages and double pages... that will reach more than 33,000,000 readers plus a great newspaper campaign in the leading markets of the country... Read the story of the great General Electric Christmas advertising promotion on page 14. Get in touch with your

G-E distributor NOW... and tie in with this great selling drive, starting this month. It pays to line up with G-E Radio. *General Electric means business!*

1 → **G-E LEADS IN SALES-MAKING FEATURES**

THE G-E BEAM-A-SCOPE

No aerials... No ground connections needed. Reduces local static interference. Gives quieter, finer reception, especially in noisy areas. It makes the new G-E one radio that does not need to be anchored in one fixed location. It operates in any spot, in any room. Just plug it in like a floor lamp... anywhere.

3 → **G-E TIME TUNING**

At last a radio that tunes itself for 24 hours ahead. Pick out the programs you want to hear on five different stations... and the G-E Automatic Program Pre-Selector brings them in without your doing another blessed thing. No re-tuning. No re-dialing. From now it's Time Tuning!

2 → **G-E KEYBOARD TOUCH TUNING**

Utterly new! A tremendous advance in automatic tuning. Lightning fast! Your program at the touch of a key. Easier tuning. More accurate tuning. A great demonstration feature that will clinch extra sales for you.

GENERAL  ELECTRIC



RADIO